

DRAPER[®]

D20
MULTI-TOOL BATTERY SYSTEM

GB ORIGINAL LANGUAGE

20V
**OSCILLATING
MULTI-TOOL**

55604 & 00595



**UK
CA** **CE**

D 20V
**OSZILLIERENDES
MULTIFUNKTIONSWERKZEUG**
55604 & 00595

E **MULTIHERRAMIENTA
OSCILANTE**
20V
55604 & 00595

F **MULTIOUTIL OSCILLANT**
20V
55604 & 00595

I 20V
UTENSILE MULTIUSO
55604 & 00595

NL 20V
**OSCILLERENDE
MULTI-TOOL**
55604 & 00595

P **MULTI-FERRAMENTA
OSCILANTE**
20V
55604 & 00595

1. INTRODUCTION



1.1 SCOPE

This oscillating multi tool is designed for detail sanding, plunge cutting, trimming of excess materials and preparing surfaces for further finishing.

As part of our core range it is suitable for enthusiasts and tradespeople alike, any application other than that it was intended for, is considered misuse.

This product is not a toy and must not be used by children or any person with reduced physical, sensory or mental capabilities or lack of experience and knowledge, or people unfamiliar with these instructions.

Local regulations may restrict the age of the operator.

1.2 UNDERSTANDING THIS MANUALS SAFETY CONTENT:

Warning! – Information that draws attention to the risk of injury or death.

Caution! – Information that draws attention to the risk of damage to the product or surroundings.

1.3 EXPLANATION OF SYMBOLS



Read the instruction manual.



Wear face mask and safety glasses.



Wear ear defenders.



Wear protective gloves.



Long hair must be tied back.



Do not abandon into the environment.



Keep out of the reach of children.



Warning!



Warning! Risk of crushing.



Direction of rotation.



Continuous A-Weighted Sound Pressure Level.



Class II construction (Double insulated).



WEEE – Waste Electrical & Electronic Equipment. Do not dispose of Waste Electrical & Electronic Equipment in with domestic rubbish.



Lithium-ion product.



Do not incinerate or throw onto fire.



For indoor use only. Do not expose to rain.



Fuse protective device.



Polarity indication.



Rated voltage.



European conformity.

2. SPECIFICATION



2.1 SPECIFICATION

Stock No's. 55604 & 00595

Part No's. D20OMT3DEG & D20OMT3DEGSET

Speed 5000 - 15,000rpm

Sound pressure level (LpA)*: 77dB(A)

Sound power level (LWA)**: 88dB(A)

Uncertainty (K): 3dB(A)

Vibration level†: 7.529m/s², K=1.5m/s²

Weight (machine only): 1.0kg

Battery pack (for 55604, sold separately):

Part No. D20B2.0AH

Type Li-Ion

Rated Voltage 20V

Rating 2.0Ah

Chargers (for 55604, sold separately):

Part No. D20BCS

Rated Voltage.....	230V~
Rated Frequency.....	50Hz
Rated D.C. output voltage	20V
Rated D.C. output current	1.65A
Protective device rated current.....	8A
Construction	Class II

the risk of electric shock.

- f) **If operating a power tool in a damp location is unavoidable, use a residual current device (RCD) protected supply.** Use of an RCD reduces the risk of electric shock.

3) Personal safety

- a) **Stay alert, watch what you are doing and use common sense when operating a power tool. Do not use a power tool while you are tired or under the influence of drugs, alcohol or medication.** A moment of inattention while operating power tools may result in serious personal injury.
- b) **Use personal protective equipment Always wear eye protection.** Protective equipment such as a dust mask, non-skid safety shoes, hard hat or hearing protection use for appropriate conditions will reduce personal injuries.
- c) **Prevent unintentional starting. Ensure the switch is in the off-position before connecting to power source and/or battery pack, picking up or carrying the tool.** Carrying power tools with your finger on the switch or energising power tools that have the switch on invites accidents.
- d) **Remove any adjusting key or wrench before turning the power tool on.** A wrench or a key left attached to a rotating part of the power tool may result in personal injury.
- e) **Do not overreach. Keep proper footing and balance at all times.** This enables better control of the power tool in unexpected situations.
- f) **Dress properly. Do not wear loose clothing or jewellery. Keep your hair and clothing away from moving parts.** Loose clothes, jewellery or long hair can be caught in moving parts.
- g) **If devices are provided for the connection of dust extraction and collection facilities, ensure these are connected and properly used.** Use of dust collection can reduce dust-related hazards.
- h) **Do not let familiarity gained from frequent use of tools allow you to become complacent and ignore tool safety principles.** A careless action can cause severe injury within a fraction of a second.

4) Power tool use and care

- a) **Do not force the power tool. Use the correct power tool for your application.** The correct power tool will do the job better and safer at the rate for which it was designed.
- b) **Do not use the power tool if the switch does not turn it on and off.** Any power tool that cannot be controlled with the switch is dangerous and must be repaired.
- c) **Disconnect the plug from the power**

3. HEALTH AND SAFETY INFORMATION



3.1 GENERAL SAFETY INSTRUCTIONS FOR POWER TOOL USE

Warning! Read all safety warnings, instructions, illustrations and specifications provided with this power tool. Failure to follow all instructions listed below may result in electric shock, fire and/or serious injury.

Save all warnings and instructions for future reference.

The term "power tools" in the warnings refers to your mains-operated (corded) power tool or battery-operated (cordless) power tool.

1) Work area safety

- a) **Keep work area clean and well lit.** Cluttered or dark areas invite accidents.
- b) **Do not operate power tools in explosive atmospheres, such as in the presence of flammable liquids, gases or dust.** Power tools create sparks which may ignite the dust or fumes.
- c) **Keep children and bystanders away while operating a power tool.** Distractions can cause you to lose control.

2) Electrical safety

- a) **Power tool plugs must match the outlet. Never modify the plug in any way. Do not use any adapter plugs with earthed (grounded) power tools.** Unmodified plugs and matching outlets will reduce risk of electric shock.
- b) **Avoid body contact with earthed or grounded surfaces, such as pipes, radiators, ranges and refrigerators.** There is an increased risk of electric shock if your body is earthed or grounded.
- c) **Do not expose power tools to rain or wet conditions.** Water entering a power tool will increase the risk of electric shock.
- d) **Do not abuse the cord. Never use the cord for carrying, pulling or unplugging the power tool. Keep cord away from heat, oil, sharp edges or moving parts.** Damaged or entangled cords increase the risk of electric shock.
- e) **When operating a power tool outdoors, use an extension cord suitable for outdoor use.** Use of a cord suitable for outdoor use reduces

source and/or remove the battery pack, if detachable, from the power tool before making any adjustments, changing accessories, or storing power tools. Such preventive safety measures reduce the risk of starting the power tool accidentally.

- d) **Store idle power tools out of the reach of children and do not allow persons unfamiliar with the power tool or these instructions to operate the power tool.** Power tools are dangerous in the hands of untrained users.
 - e) **Maintain power tools and accessories. Check for misalignment or binding of moving parts, breakage of parts and any other condition that may affect the power tool's operation. If damaged, have the power tool repaired before use.** Many accidents are caused by poorly maintained power tools.
 - f) **Keep cutting tools sharp and clean.** Properly maintained cutting tools with sharp cutting edges are less likely to bind and are easier to control.
 - g) **Use the power tool, accessories and tool bits etc. in accordance with these instructions, taking into account the working conditions and the work to be performed.** Use of the power tool for operations different from those intended could result in a hazardous situation.
 - h) **Keep handles and grasping surfaces dry, clean and free from oil and grease.** Slippery handles and grasping surfaces do not allow for safe handling and control of the tool in unexpected situations.
- 5) **Service**
- a) **Have your power tool serviced by a qualified repair person using only identical replacements parts.** This will ensure that the safety of the power tool is maintained.

3.2 ADDITIONAL SAFETY INSTRUCTIONS FOR OSCILLATING MULTI TOOLS

Warning!

- 1) **Safety instructions for all operations**
 - a) **Hold the power tool by insulated gripping surfaces, because the sanding surface may contact its own cord.** Cutting a "live" wire may make exposed metal parts of the power tool "live" and could give the operator an electric shock.

3.3 SAFETY INSTRUCTIONS FOR MAINS POWERED CHARGERS & BATTERY PACKS

Chargers

- The charger is for indoor use only.
- Prior to plugging the charger in to the supply, check that the plug, cable and charger casing are in good condition. If any are damaged, have the defective part(s) replaced immediately by a suitably qualified person.
- Only use a correctly rated mains outlet to provide power, do not plug into site generators, attach to engine generators or D.C. sources. Do not use a mains socket outlet that is not switched.
- Use the correct Draper charger in conjunction with it's corresponding battery pack (consult the Draper website for more information or to find your local stockist).
- Do not charge any other batteries with Draper chargers. Any other application is considered misuse.
- Do not attempt to charge battery packs that are too hot (over 30°C) or too cold (under 5°C), if these conditions apply set the battery pack aside to "normalise" before proceeding with the charging operation.
- Set up the charger and cable in a safe place where it won't be knocked, tripped over, stepped on, etc. and where it is well ventilated. Make sure the ventilation slots in the charger case are not obstructed.
- Inspect the battery pack for damage, if it is undamaged, plug it into the charger, ensuring the correct orientation.
- Switch the charger on and check that the correct indicators illuminate, allow the battery pack to charge (see the specific instructions for your charger). Once charging is complete, switch the charger off, disconnect from power supply, remove the battery pack and store.

Battery packs

- Before charging, read the instructions.
- Do not expose to rain.
- Only use Draper D20 battery packs with this product. Consult your Draper stockist for details.
- Do not charge any other batteries with Draper chargers. Any other application is considered misuse.
- The charger must be disconnected from the power supply before removing the battery.
- The battery must be removed from the appliance before it is recycled.
- The battery is to be disposed of in-line with local authority procedures.
- Do not crush, open or burn the battery. Exposure to

potentially harmful materials may occur.



- In case of fire use CO₂ or dry chemical extinguisher.
- Do not expose to high temperatures >50°C. The battery may degrade at high temperatures.
- Charge battery in conditions between 5°C to 30°C with the designated charger for the battery.
- Do not use battery if it has been stored at 5°C or less. Allow it to “normalise” at room temperature before usage/charging.

Warning! – Leaking battery packs

- The electrolyte in battery packs is corrosive. Avoid contact with the skin.
- If contact is made, flush the area with clean water, pat dry and seek medical attention at the earliest opportunity.
- Inform medical personnel that the contaminant is a “high alkaline, corrosive liquid”.
- If electrolyte comes into contact with the eyes, flush with copious amounts of water only. Seek immediate medical attention, relaying the information above.

3.4 CONNECTION TO THE POWER SUPPLY (CHARGER)

Caution: Risk of electric shock. Do not open.

This appliance is supplied with an approved plug and cable for your safety. The value of the fuse fitted is marked on the pin face of the plug. Should the fuse need replacing, ensure the substitute is of the correct rating, approved to BS1362 and ASTA  or BSI Kite  marked.

Ensure the fuse cover is replaced before attempting to connect the plug to an electrical outlet. If the cover is missing, a replacement must be obtained or the plug replaced with a suitable type.

If a replacement plug is to be fitted this must be carried out by a qualified electrician.

Never use a damaged or incomplete plug.

This appliance is Class II[†] and is designed for connection to a power supply matching that detailed on the rating label and compatible with the plug fitted.

Carefully select an extension lead. Some machines are not suitable for use with extension leads. If the tool is designed for use outdoors, only use an extension lead suitable for that environment in conjunction with an RCD adaptor. When using an extension lead, select one capable of handling the current (amps) drawn by the machine in use. Ensure the cable is fully unwound regardless of the distance between the power supply and the tool. Excess current (amps) and a coiled extension lead will cause the cable to heat up and can result in fire.

Keep extension leads away from moving hazardous parts to avoid damages to the cable which can lead to contact with live parts. Position cable safely to avoid

tripping over.

[†]Double insulated : This product requires no earth connection as supplementary insulation is applied to the basic insulation to protect against electric shock in the event of failure of the basic insulation.

Important! If using an extension lead, follow the instructions that came with your lead regarding maximum load while cable is wound. If in doubt, ensure that the entire cable is unwound. Using a coiled extension lead will generate heat which could melt the lead and cause a fire.

4. UNPACKING AND CHECKING



4.1 PACKAGING

Carefully remove the product from the packaging and examine it for any sign of damage. Check contents against the parts shown in Fig A. If any part is damaged or missing, please contact the Draper Help Line (see back page). Do not attempt to use the product!

The packaging material should be retained during the warranty period, in case the product needs to be returned for repair.

Warning!

- Some of the packaging materials may be harmful to children. Do not leave any of these materials in reach of children.
- If any of the packaging is to be thrown away, make sure they are disposed of correctly, according to local regulations.

5. IDENTIFICATION – FIG.A

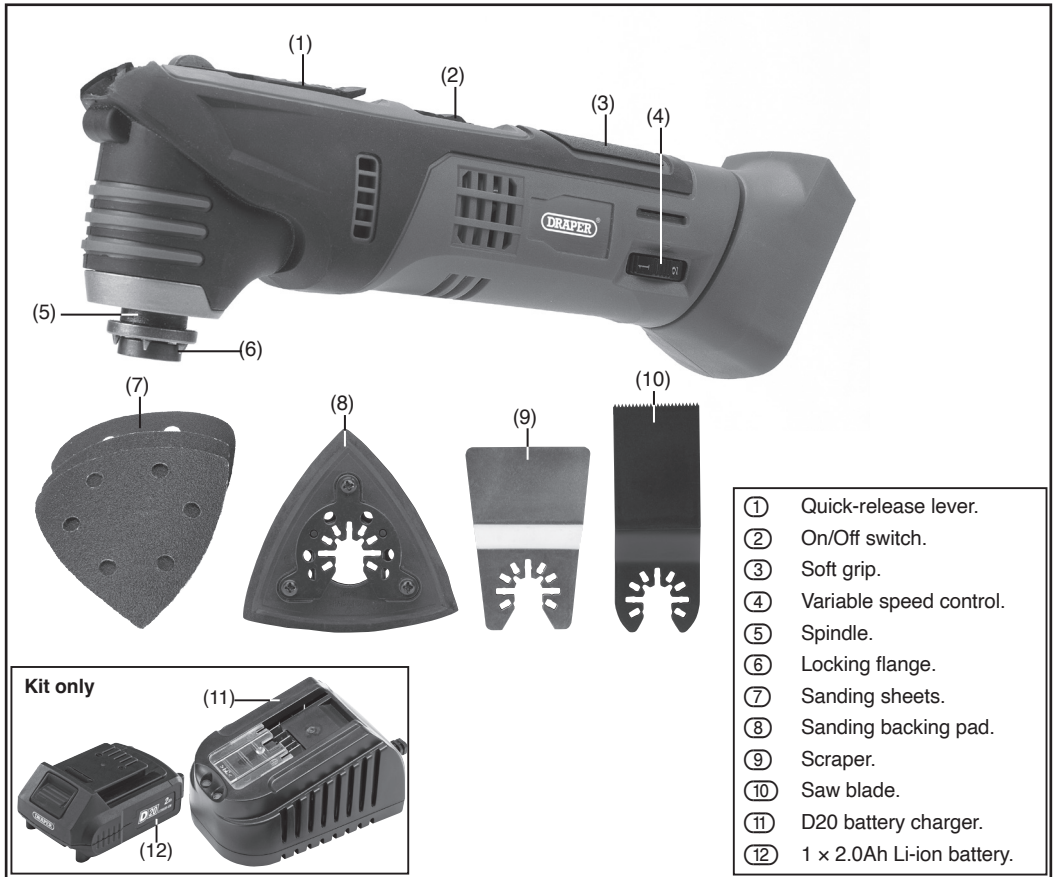

FIG.A

6. BASIC OPERATIONS

Note: For details of our full range of accessories, please visit drapertools.com

6.1 ATTACHING THE SANDING BACKING PAD – FIGS. 1 - 4

Note: Switch off the Multi-tool and remove the battery from the machine before carrying out adjustments, servicing or maintenance.

Caution: For all work or when changing application tools, always wear protective gloves. Avoid danger of injury from the sharp edges of the application tools. Application tools can become very hot while working, presenting danger of burns.

Warning!

To reduce the risk of injury, do not let the universal saw blades or any segment saw blades face back toward the user's hand.

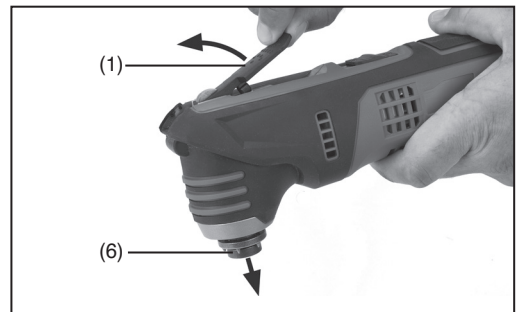

FIG. 1

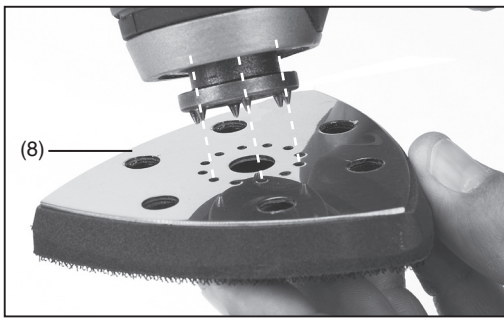

FIG. 2

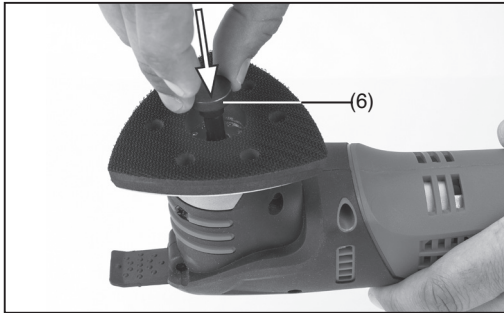

FIG. 3

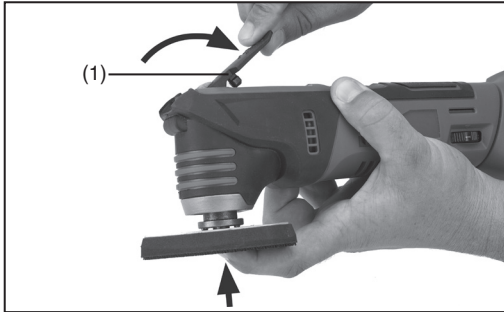

FIG. 4

6.2 MOUNTING/CHANGING THE SANDING SHEET – FIG. 5

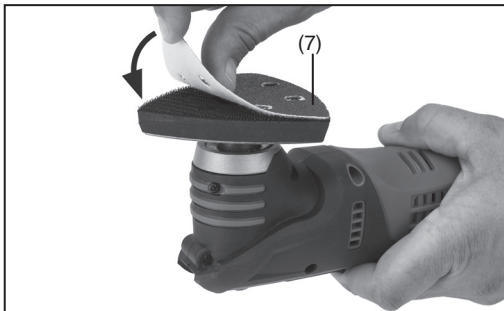

FIG. 5

6.3 FITTING THE TOOL ATTACHMENTS – FIGS. 6 – 7

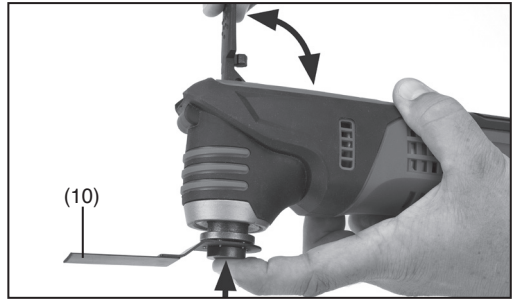

FIG. 6

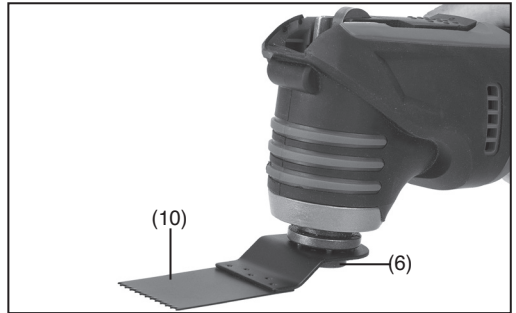

FIG. 7

6.4 OPERATING THE ON/OFF SWITCH – FIG. 8



FIG. 8

6.5 USING THE VARIABLE SPEED CONTROL – FIG. 9

Warning!

Select oscillation frequency (speed) while the motor is running. The variable speed control (4) can be used to set the optimum oscillating frequency according to the accessories used and the respective application.

High oscillation frequency:

Sanding, sawing, rasping and polishing stone and metal.

Low oscillation frequency:

Polishing varnishes.

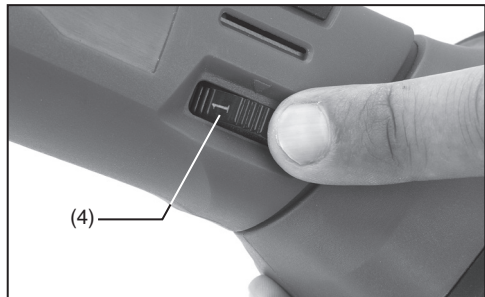

FIG. 9

6.6 SANDING

Typical application: wood, metal, small areas, especially corners, edges and places difficult to access. Select high oscillation frequency.

Sand with a constant movement and light pressure. Heavy pressure does not increase the removal - the sanding sheet merely wears faster.

6.7 SAWING WITH THE OFFSET SAW BLADE

Typical application: wood, plastics, sheet metal. Select high oscillation frequency.

The saw blade lasts longer if the wear is distributed evenly. To ensure an even distribution, loosen the saw blade, rotate it and retighten firmly.

6.8 BATTERY PACK CHARGING – FIGS. 10 – 11

55604 is supplied “bare”, without battery pack or charger. For compatible batteries, chargers and accessories please visit www.drapertools.com.

Important! Draper designated battery packs and chargers must only be used with this product. Use of any other third-party battery packs/chargers is considered misuse and will invalidate the warranty.

Once connected to the mains supply, recharging of the battery can be left generally unsupervised.

⚠ Warning! Check the condition of the charger and battery prior to each charge. Do not use if there is any sign of damage.

The battery pack is supplied un-charged and must be charged before initial use.

To charge the battery pack (12) :

- Plug the battery charger (11) unit into a suitable mains power supply socket.
- The red LED (11.1) will illuminate to show the charger

has power.

- Slide the battery into the charger’s aligning pins.
- After a few seconds delay, the red LED will flash to show that charging has begun, then changes to solid red.
- Whilst the battery is charging, the green LED (11.2) will flash, (the red LED will go from flashing to constant red.
- When the battery is fully charged when the green LED stops flashing and changes to solid green. The red LED will turn off.



FIG. 10

To release the battery pack:

- Press the battery release button (12.1) and gently slide the battery pack off.

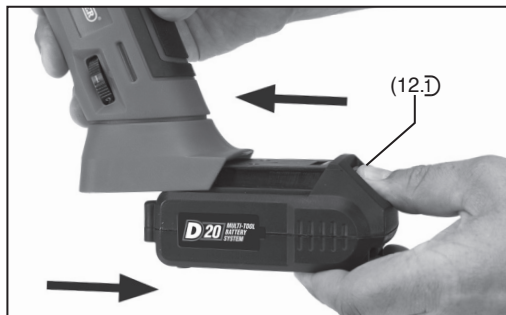

FIG. 11

6.9 BATTERY PACK PROTECTION FEATURES

Overcharging protection: When the battery pack is fully charged, the transformer/charger will automatically shut off, protecting the internal components.

Over-discharging protection: Stops the battery pack from discharging beyond the recommended lowest safety voltage.

Overheating protection: An internal thermistor cut-off sensor shuts off the battery pack should it become too hot during operation. For example, if the tool is overloaded or used for extended periods. 30 minutes cooling time may be required.

Current protection: If the battery is overloaded or the maximum current draw exceeded, the battery will shut off to protect internal components. The battery pack will resume operation once the current draw is at a safe level.

Short circuit protection: The battery pack will stop operating immediately if it was to short circuit.

6.10 BATTERY PACK CHARGE STATUS – FIG.12

Press the charge level indicator button (12.2) to display the battery charge level.

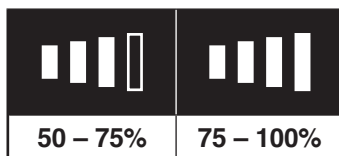
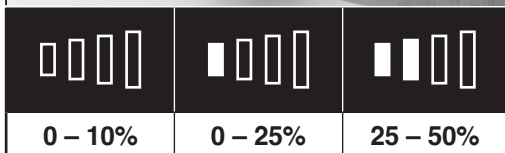

FIG. 12

6.11 BATTERY LIFE EFFICIENCY AND CHARGING ADVICE

- A rechargeable battery will be hot immediately after use. If such a battery is recharged immediately after use the battery life will be shortened. Leave the battery and recharge it after it has cooled.
- The battery needs to be warmed-up or cooled down to prevent damaging to the batteries internal components. maximum current draw exceeded, the battery will shut off to protect internal components. The battery pack will resume operation once the current draw is at a safe level.

7. MAINTENANCE AND TROUBLESHOOTING

7.1 TROUBLESHOOTING GUIDE

Problems	Possible cause	Required action
Tool does not operate.	<ul style="list-style-type: none"> – Battery pack no charge. – Battery pack faulty or damaged. 	<ul style="list-style-type: none"> – Re-charge battery pack. – Replace battery pack.
Motor runs, but slowly/ losing power.	<ul style="list-style-type: none"> – Battery pack no charge. – Battery pack faulty or damaged. 	<ul style="list-style-type: none"> – Re-charge battery pack. – Replace battery pack.
Battery pack doesn't charge / non-illumination / non illumination of charger.	<ul style="list-style-type: none"> – Fuse blown in charger plug. – Charger faulty. 	<ul style="list-style-type: none"> – Replace fuse. – Replace charger.

7.2 MAINTENANCE

Regular inspection and cleaning reduces the necessity for maintenance operations and will keep your tool in good working condition.

Do not use solvents or fuels to clean the product. When not in use, store the product in a safe, dry place.

8. WARRANTY



8.1 WARRANTY

Draper power tools have been carefully tested & inspected and are guaranteed to be free from defective materials or workmanship.

For details of warranty and terms and conditions please visit the Draper Tools website at www.drapertools.com/warranty

9. DISPOSAL



9.1 DISPOSAL

- At the end of the machine's working life, or when it can no longer be repaired, ensure that it is disposed of according to national regulations.
- Contact your local authority for details of collection schemes in your area.

In all circumstances:

- Do not dispose of power tools with domestic waste.
- Do not incinerate.
- Do not dispose of WEEE* as unsorted municipal waste.



Li-ion

* *Waste Electrical & Electronic Equipment.*

9.2 BATTERY PACK DISPOSAL INFORMATION

Warning!

- Do not put battery packs in a fire or mutilate – cells may burst or release toxic materials.
- Do not short circuit cells, may cause burns.
- The battery pack must be removed from the appliance before it is scrapped.
- The battery pack is to be disposed of safely.
- Do not mutilate batteries, corrosive electrolyte will be released.
- Do not dispose of batteries or cells in a charged condition.

Expired batteries must be recycled/disposed of in accordance with the appropriate regulation or legislation. They should be returned to your local warranty agent/stockist.