



DRAPER[®]

230V

VARIABLE SPEED METAL LATHE

33893

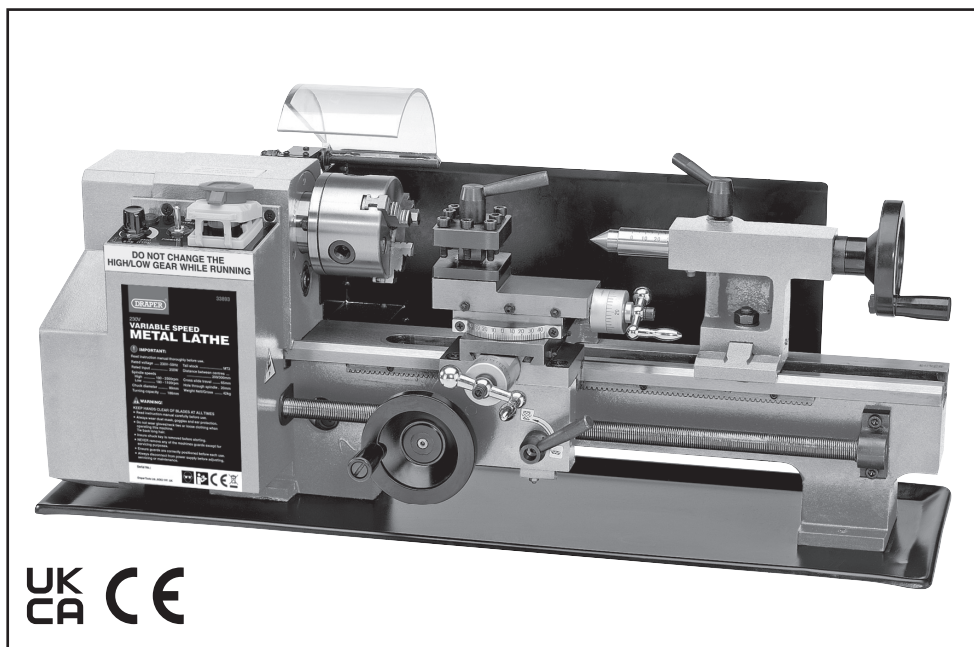

These instructions accompanying the product are the original instructions. This document is part of the product, keep it for the life of the product passing it on to any subsequent holder of the product. Read all these instructions before assembling, operating or maintaining this product.

This manual has been compiled by Draper Tools describing the purpose for which the product has been designed, and contains all the necessary information to ensure its correct and safe use. By following all the general safety instructions contained in this manual, it will ensure both product and operator safety, together with longer life of the product itself.

All photographs and drawings in this manual are supplied by Draper Tools to help illustrate the operation of the product.

Whilst every effort has been made to ensure the accuracy of information contained in this manual, the Draper Tools policy of continuous improvement determines the right to make modifications without prior warning.

1. TITLE PAGE

1.1 INTRODUCTION:

USER MANUAL FOR: 230V 370W VARIABLE SPEED METAL LATHE

Stock No: 33893

Part No: LATHE-300

1.2 REVISIONS:

Date first published October 2019.

Revised version September 2022.

As our user manuals are continually updated, users should make sure that they use the very latest version.

Downloads are available from: <http://drapertools.com/manuals>

Draper Tools Limited
Hursley Road
Chandler's Ford
Eastleigh
Hampshire
SO53 1YF
UK

Delta International BV
Oude Graaf 8
6002 NL
Weert
Netherlands

Website: drapertools.com

Product Helpline: +44 (0) 23 8049 4344

General Fax: +44 (0) 23 8026 0784

1.3 UNDERSTANDING THIS MANUALS SAFETY CONTENT:

WARNING! – Information that draws attention to the risk of injury or death.

CAUTION! – Information that draws attention to the risk of damage to the product or surroundings.

1.4 COPYRIGHT © NOTICE:

Copyright © Draper Tools Limited.

Permission is granted to reproduce this publication for personal and educational use only. Commercial copying, redistribution, hiring or lending is prohibited.

No part of this publication may be stored in a retrieval system or transmitted in any other form or means without written permission from Draper Tools Limited.

In all cases this copyright notice must remain intact.

3. WARRANTY

3.1 WARRANTY

Draper tools have been carefully tested and inspected before shipment and are guaranteed to be free from defective materials and workmanship.

Should the tool develop a fault, please return the complete tool to your nearest distributor or contact

Draper Tools Limited, Chandler's Ford, Eastleigh, Hampshire, SO53 1YF. England.

Telephone Sales Desk: (023) 8049 4333 or Product Help Line (023) 8049 4344.

A proof of purchase must be provided with the tool.

If upon inspection it is found that the fault occurring is due to defective materials or workmanship, repairs will be carried out free of charge. This warranty period covering labour is 12 months from the date of purchase except where tools are hired out when the warranty period is 90 days from the date of purchase. The warranty is extended to 12 months for parts only. This warranty does not apply to any consumable parts, any type of battery or normal wear and tear, nor does it cover any damage caused by misuse, careless or unsafe handling, alterations, accidents, or repairs attempted or made by any personnel other than the authorised Draper warranty repair agent.

Note: If the tool is found not to be within the terms of warranty, repairs and carriage charges will be quoted and made accordingly.

This warranty applies in lieu of any other warranty expressed or implied and variations of its terms are not authorised.

Your Draper warranty is not effective unless you can produce upon request a dated receipt or invoice to verify your proof of purchase within the warranty period.

Please note that this warranty is an additional benefit and does not affect your statutory rights.

Draper Tools Limited.

4. INTRODUCTION

4.1 SCOPE

Precision built metal working lathe capable of cutting metric gears. Variable speed reversible drive and powered cutting facility for right and left hand threads. No-volt switch to prevent accidental switch on with the chuck guard fitted as standard. Supplied with self-centring three jaw chuck and approved plug. Extensive range of accessories available.

4.2 SPECIFICATION

Stock No.	33893
Part No.	LATHE-300
Rated Voltage	230V~50Hz
Rated input	370W
Spindle speeds	
High	100-2500r/min
Low	100-1100r/min
Chuck diameter	80mm
Turning capacity	180mm
Tail stock	MT2
Distance between centres	200/300mm
Cross slide travel	65mm
Hole through spindle	20mm
Weight nett/gross	42kg

ALWAYS WEAR APPROVED SAFETY GOGGLES AND EAR DEFENDERS.

4.3 HANDLING AND STORAGE

Care must still be taken when handling and lifting. Dropping this machine will have an effect on the accuracy and may also result in personal injury. This machine is not a toy and must be respected.

The environment will have a negative result on its operation if you are not careful. If the air is damp, components will rust. If the machine is unprotected from dust and debris; components will become clogged: And if not cleaned and maintained correctly or regularly the machine will not perform at its best.

5. HEALTH AND SAFETY INFORMATION

5.1 GENERAL POWER TOOL SAFETY WARNINGS

WARNING Read all safety warnings, instructions, illustrations and specifications provided with this power tool. *Failure to follow all instructions listed below may result in electric shock, fire and/or serious injury.*

Save all warnings and instructions for future reference.

The term "power tool" in the warnings refers to your mains-operated (corded) power tool or battery-operated (cordless) power tool.

Work area safety

Keep work area clean and well lit. *Cluttered or dark areas invite accidents.*

Do not operate power tools in explosive atmospheres, such as in the presence of flammable liquids, gases or dust. *Power tools create sparks which may ignite the dust or fumes.*
Keep children and bystanders away while operating a power tool. *Distractions can cause you to lose control.*

Electrical safety

Power tool plugs must match the outlet. Never modify the plug in any way. Do not use any adapter plugs with earthed (grounded) power tools. *Unmodified plugs and matching outlets will reduce risk of electric shock.*

Avoid body contact with earthed or grounded surfaces, such as pipes, radiators, ranges and refrigerators. *There is an increased risk of electric shock if your body is earthed or grounded.*
Do not expose power tools to rain or wet conditions. *Water entering a power tool will increase the risk of electric shock.*

Do not abuse the cord. Never use the cord for carrying, pulling or unplugging the power tool. Keep cord away from heat, oil, sharp edges or moving parts. *Damaged or entangled cords increase the risk of electric shock.*

When operating a power tool outdoors, use an extension cord suitable for outdoor use. *Use of a cord suitable for outdoor use reduces the risk of electric shock.*

If operating a power tool in a damp location is unavoidable, use a residual current device (RCD) protected supply. *Use of an RCD reduces the risk of electric shock.*

Personal safety

Stay alert, watch what you are doing and use common sense when operating a power tool. Do not use a power tool while you are tired or under the influence of drugs, alcohol or medication. *A moment of inattention while operating power tools may result in serious personal injury.*

Use personal protective equipment. Always wear eye protection. *Protective equipment such as a dust mask, non-skid safety shoes, hard hat or hearing protection used for appropriate conditions will reduce personal injuries.*

Prevent unintentional starting. Ensure the switch is in the off-position before connecting to power source and/or battery pack, picking up or carrying the tool. *Carrying power tools with your finger on the switch or energising power tools that have the switch on invites accidents.*

Remove any adjusting key or wrench before turning the power tool on. *A wrench or a key left attached to a rotating part of the power tool may result in personal injury.*

Do not overreach. Keep proper footing and balance at all times. *This enables better control of the power tool in unexpected situations.*

Dress properly. Do not wear loose clothing or jewellery. Keep your hair and clothing away from moving parts. *Loose clothes, jewellery or long hair can be caught in moving parts.*

If devices are provided for the connection of dust extraction and collection facilities, ensure these are connected and properly used. *Use of dust collection can reduce dust-related hazards.*

Do not let familiarity gained from frequent use of tools allow you to become complacent and ignore tool safety principles. *A careless action can cause severe injury within a fraction of a second.*

Power tool use and care

Do not force the power tool. Use the correct power tool for your application. *The correct*

5. HEALTH AND SAFETY INFORMATION

power tool will do the job better and safer at the rate for which it was designed.

Do not use the power tool if the switch does not turn it on and off. *Any power tool that cannot be controlled with the switch is dangerous and must be repaired.*

Disconnect the plug from the power source and/or remove the battery pack, if detachable, from the power tool before making any adjustments, changing accessories, or storing power tools. *Such preventive safety measures reduce the risk of starting the power tool accidentally.*

Store idle power tools out of the reach of children and do not allow persons unfamiliar with the power tool or these instructions to operate the power tool. *Power tools are dangerous in the hands of untrained users.*

Maintain power tools and accessories. Check for misalignment or binding of moving parts, breakage of parts and any other condition that may affect the power tool's operation. If damaged, have the power tool repaired before use. *Many accidents are caused by poorly maintained power tools.*

Keep cutting tools sharp and clean. *Properly maintained cutting tools with sharp cutting edges are less likely to bind and are easier to control.*

Use the power tool, accessories and tool bits etc. in accordance with these instructions, taking into account the working conditions and the work to be performed. *Use of the power tool for operations different from those intended could result in a hazardous situation.*

Keep handles and grasping surfaces dry, clean and free from oil and grease. *Slippery handles and grasping surfaces do not allow for safe handling and control of the tool in unexpected situations.*

Service

Have your power tool serviced by a qualified repair person using only identical replacement parts. *This will ensure that the safety of the power tool is maintained.*

5.2 TOOL SAFETY WARNING

1) Training

- a) Read the instructions carefully. be familiar with the proper use of the appliance.
- b) Never allow children to use the appliance.
- c) Never allow people unfamiliar with the instructions to use the appliance. Local regulations may restrict the age of the operator.
- d) Never operate the appliance while people, especially children or pets are nearby.
- e) The operator or user is responsible for accidents or hazards occurring to other people or their property.

2) Preparation:

- a) While operating the appliance, always wear substantial footwear and long trousers.
- b) Do not wear loose clothing or jewellery that can be drawn into the air inlet. Keep long hair away from the air inlets.
- c) Wear protective goggle while operating.
- d) to prevent dust irritation, the wearing of a face mask is recommended.
- e) Before using, check the supply and extension cord for signs of damage and aging. Do not use the appliance if the cord is damaged or worn.
- f) Never operate the appliance with defective guards or shields, or without safety devices, for example debris collector in place
- g) Only use a weather proof extension cable fitted with a coupler according to IEC 60320-2-3.

3. Operation:

- a) Always direct the cable to the rear away from the appliance.
- b) If a cord becomes damaged during use, disconnect the supply cord from the main immediately.

DO NOT TOUCH THE CORD BEFORE DISCONNECTING THE SUPPLY.

5. HEALTH AND SAFETY INFORMATION

- c) Do not carry the appliance by the cable.
 - d) Disconnect the appliance from the main supply:
 - Whenever you leave the machine.
 - Before cleaning a blockage.
 - Before checking, cleaning or working on the appliance.
 - If the appliance starts to vibrate abnormally.
 - e) Operate the appliance only in daylight or in good artificial light.
 - f) Do not overreach and keep your balance at all times.
 - g) Always be sure of your footing on slopes.
 - h) Walk, never run.
 - i) Keep all cooling air inlets clear of debris.
 - j) Never blow debris in the direction of bystanders.
4. Maintenance & Storage:
- a) Keep all nuts, bolts and screws tight to be sure the appliance is in safe working condition.
 - b) Check the debris collector frequently.
 - c) Replace worn or damaged parts.
 - d) Use only genuine replacement parts and accessories.
 - e) Store the appliance only in a dry place.

5.3 CONNECTION TO THE POWER SUPPLY

CAUTION: Risk of electric shock. Do not open.

This appliance is supplied with a moulded 3 pin mains plug for your safety. The value of the fuse fitted is marked on the pin face of the plug. Should the fuse need replacing, ensure the substitute is of the correct rating, approved to BS1362 and ASTA or BS Kite marked.

ASTA 

BSI 

The fuse cover is removable with a small plain slot screwdriver. Ensure the fuse cover is replaced before attempting to connect the plug to an electrical outlet. If the cover is missing, a replacement must be obtained or the plug replaced with a suitable type.

If a replacement plug is to be fitted this must be carried out by a qualified electrician.

The damaged or incomplete plug, when cut from the cable shall be disabled to prevent connection to a live electrical outlet.

This appliance is Class I[†] and is designed for connection to a power supply matching that detailed on the rating label and compatible with the plug fitted.

If an extension lead is required, use an approved and compatible lead rated for this appliance. Follow all the instruction supplied with the extension lead.

[†]Earthed : This product requires an earth connection to protect against electric shock from accessible conductive parts in the event of a failure of the basic insulation.

IMPORTANT

If using an extension lead, follow the instructions that came with your lead regarding maximum load while cable is wound. If in doubt, ensure that the entire cable is unwound. Using a coiled extension lead will generate heat which could melt the lead and cause a fire.

FEATURES

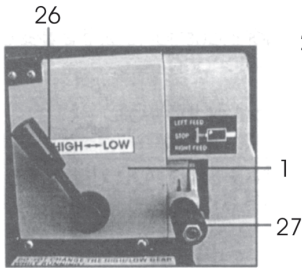
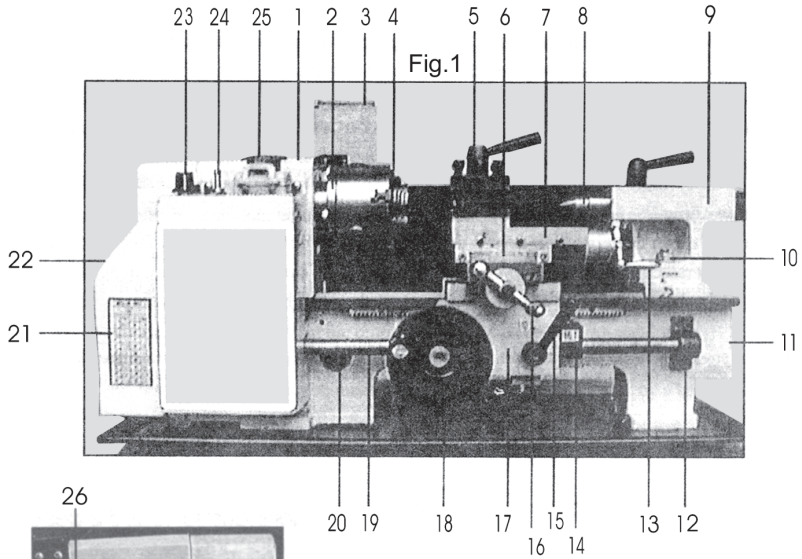

Rear view of headstock

LEGEND

- | | |
|---------------------------------------|---|
| 1. Headstock | 15. Automatic Feed Lever |
| 2. Spindle Flange | 16. Cross-Slide Feed Handle |
| 3. Chuck Guard (Accessory) | 17. Apron |
| 4. 3-Jaw Chuck | 18. Manual (Saddle) Feed Handle |
| 5. Tool Post | 19. Leadscrew |
| 6. Cross-Slide | 20. Motor Brush Cap |
| 7. Compound Slide | 21. Thread Dial Indicator Table (Accessory) |
| 8. Tailstock Centre | 22. Running Gear Cover |
| 9. Tailstock | 23. Variable Speed Control Knob |
| 10. Tailstock Securing Nut | 24. Forward/Off/Reverse Switch |
| 11. Bed | 25. Emergency Stop Switch |
| 12. R.H. Leadscrew Bearing | 26. High/Low Speed Range Lever |
| 13. Compound Slide Feed Handle | 27. Leadscrew Fwd/Neutral/Rvrse Lever |
| 14. Thread Dial Indicator (Accessory) | |

1. THE HEADSTOCK

The motor provides a direct drive to the Spindle via an internal tooth type belt. Spindle speed is variable, and is regulated by the Speed Control Knob (23), located on the main control panel.

The spindle, is provided with an internal No.3 Morse taper to accommodate a centre for use with a face plate or turning clamp.

The 3-Jaw, Self Centering Chuck (4) is mounted on the Spindle Flange (2). To remove the chuck, simply remove the three securing nuts to the rear of the flange allowing it to be pulled free together with the three mounting studs.

Three external jaws are also supplied which extend the capacity, of the chuck. Their uses and method of assembly is described under 'Accessories'

The spindle has 6 holes drilled in its flange to accommodate a range of fixtures such as a Face Plate, 4-Jaw chuck etc., (See Accessories)

2. THE RUNNING GEAR

The Running Gear, is protected by a cover (22), which is removed by unscrewing the two securing hex. screws.

The gear train, shown in Fig. 2, transmits drive to the lead screw. The Lead Screw acts as a worm and by operating the Auto Feed Lever (15), which engages a nut with the lead screw (worm), drive is transmitted to the saddle, and consequently the cutting tool, thereby providing a power feed for screw cutting or general turning operations. The rotational speed of the lead screw, and hence the rate of feed of the cutting tool, is determined by the gear configuration. This is explained in greater detail under Screwcutting.

The drive to the leadscrew may be disconnected by operating the lever (27), and the same lever is used to drive the leadscrew in a forward or reverse direction. (These actions are described in detail under 'Screwcutting')

Fig.2

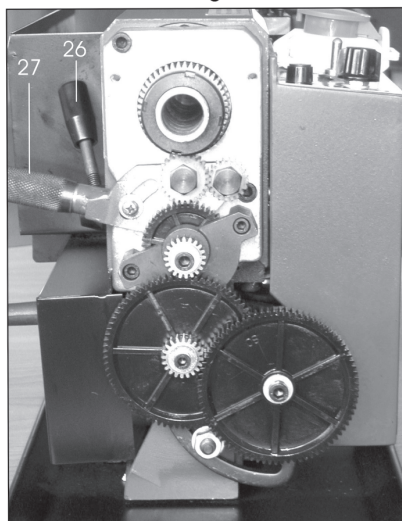

3. THE TAILSTOCK

The Tailstock (9), may be moved along the bed to any desired position and is secured in position by a single nut(10), at its base. The Tailstock Spindle carries an internal No.2 Morse taper for use with the Centre (8) provided. A Revolving Centre and Drill Chuck are also available from your dealer. (See Accessories)

4. THE SADDLE

The Saddle carries the Cross-Slide (6), on to which is mounted the Compound Slide (7) with Tool Post (5) allowing intricate and delicate operations to be performed. It may be driven by the Leadscrew, via a Drive Nut, to provide automatic feed when the Auto Feed lever (15), mounted on the Apron (17), is operated.

The position of the tool is effected by turning the cross-slide feed handle (16), which moves it across the lathe, and the saddle or manual feed handle (18), which moves it longitudinally. Additionally the compound slide feed handle (13) may be used to move the tool by small amounts at right angles to the cross-slide, or the slide may be set at an angle to the cross-slide so that short tapers or bevels may be cut. This is described in greater detail under 'Bevel Cutting' .

The cross-slide and compound slide feeds are provided with a scale. These are used to move the tool by precise amounts - one division being equivalent to 0.001" (0.025mm). As the feed handle is turned, so does the scale. The scale on the cross-slide feed may also be held stationary whilst the handle is turned, allowing the scale to be 'zeroed'. The manner in which this is put to use is discussed in greater detail under 'Operation'.

The tool post carries 8 hex socket head screws which are used to secure a cutting tool in any desired position. Four may be mounted for convenience and to speed up your operation. Two are shown mounted.

The tool post is rotated by slackening the lever (A) on its top, sufficient for the post to be lifted slightly and then turned to the desired position.

ALWAYS ensure the post, and hence the tool, is secured by screwing down the lever firmly before attempting to cut.

Fig.3

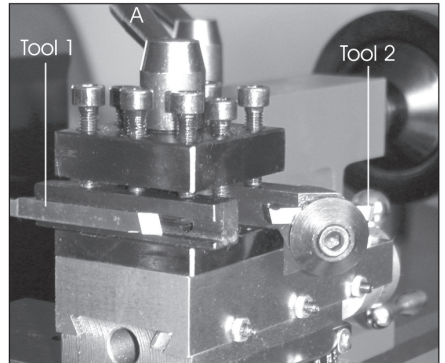

5. THE MOTOR

It is not recommended that you dis-assemble the motor. Brushes may be replaced as described under 'Maintenance'. For all other servicing and repairs, please contact your dealer.

UNPACKING & PREPARING FOR USE

On receipt, carefully unpack the lathe, inspect to ensure that no damage was suffered in transit and all parts are accounted for. Should any damage be apparent, or parts are missing, please contact your dealer immediately.

The following loose items are to be found in the packing case.

1. 4 x Rubber Feet.*
2. 4 x M6 Pan Head Screws.*
3. 4 x Hex.Keys.
4. 1 x Chuck Key.
5. 1 x Plastic Oil Container.*
6. 1 x Spare Fuse glass type.*
7. 2 x Plastic Handles w/Nuts and Bolts.*
8. No.2 Morse Taper Centre (for Tailstock).
9. 3 x External Jaws (for 3-Jaw Chuck).
- 10.2 x Double Open Ended Spanners 8x10mm and 14x17mm

Fig.4

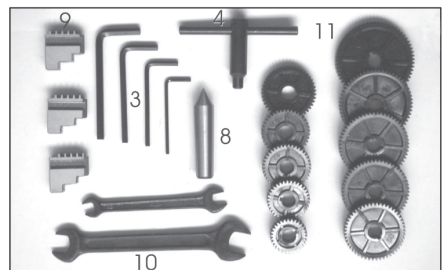

11. 1 x Gear Set. Imperial-2,30,35,40,40,45,50,55,57,60,65
(Metric-2,30,35,40,40,50,60)*

* denotes not illustrated.

With assistance, considering the weight of the machine, raise it on to a good solid surface or workbench. Proceed to remove all traces of preservative with paraffin or good quality solvent, and lightly oil all machined surfaces.

You will notice that, for transit purposes, the cross slide feed handle has been mounted in reverse. Remove it, by unscrewing the hex. socket head screw securing it, and mount it the correct way round. Then turn all feed handles to ensure they are free and move evenly and smoothly.

Attach the plastic handles to the rims of the manual feed and tailstock feed handwheels respectively, ensuring the nuts are tight and the handles spin freely about the bolts, without excessive end play.

Saddle, cross-slide and compound slide adjustments are all factory set to ensure smooth movement in both directions. If however the adjustments have been upset during transit, indicated by stiff or erratic movement, refer to 'Settings and Adjustments' for the methods of adjustment.

All hex. keys and spanners necessary to carry out various adjustments are supplied, together with a chuck key for the 3-Jaw chuck and a spare fuse. The fuse holder is located on the main control panel.

The four rubber feet are attached to the underside of the bed, using the four M6 pan head screws, in the tapped holes provided. These screws are also used to secure the chip tray. We strongly recommend however, that to provide maximum stability and additional safety, you secure the lathe to a firm foundation as described under 'Mounting the lathe'.

The three external jaws for the 3-Jaw self centering chuck, extend the capacity of the chuck, and are discussed in greater detail under 'Accessories'.

INSTALLATION

CAUTION!

DO NOT ATTEMPT TO USE THE MACHINE UNTIL INSTALLATION IS COMPLETED, AND ALL PRELIMINARY CHECKS HAVE BEEN MADE IN ACCORDANCE WITH THIS MANUAL.

MOUNTING THE LATHE

The lathe should be mounted on a strong, heavy workbench, of sufficient height so that you do not need to bend your back to perform normal operations. Take the necessary precautions when moving the lathe considering its weight. Assistance will be required.

Ensure the location is adequately lit and that you will not be working in your own shadow.

We strongly recommend that the machine is bolted firmly to a strong workbench using the tapped holes used to secure the feet to the lathe. This is to provide added stability and consequently, additional safety.

To do this, remove the four M6 screws which secure the rubber feet and chip tray to the machine (if already fitted) and discard the feet. Drill four M6 clearance holes in a worktop, at the dimensions shown in the diagram opposite, and with appropriate length M6 bolts, or screws, with flat washers, (not supplied) proceed to secure the lathe to the worktop ensuring the chip tray is in place.

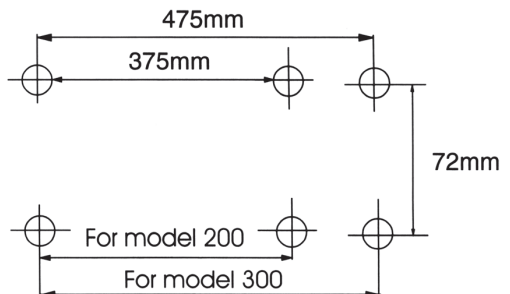

Alternatively, if you do not wish for a permanent installation, you may secure the lathe to a 5/8" thick plywood board with a minimum recommended dimension of 800x300mm, the mounting holes being centralised on the board. When the lathe is in use, the board should be clamped to work-bench using with 'G' clamps.

STARTING PROCEDURE

A. DURING INSTALLATION - INITIAL START (ref. Fig.5)

Taking all precautions previously stated, set the High - Low range lever (item 26) to LOW. Ensuring the cross-slide is well away from the chuck, and the automatic feed lever is in its disengaged position. (i.e.lever is UP), insert the electric plug into its socket.

Select FORWARD, using the Forward/Off/Reverse (F/O/R) switch (C). on the main control panel, then release the Emergency Stop switch by pushing down on the red knob slightly and pushing it in towards the headstock, as indicated by the arrow on the top of the red knob (B).

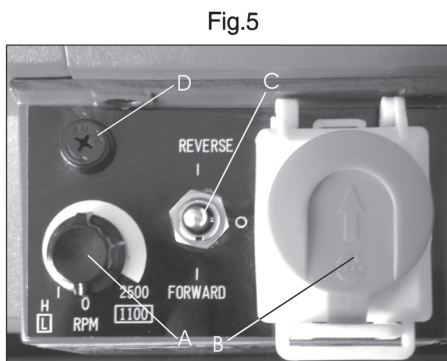

Switch on the machine by GENTLY turning the Variable Speed control knob (A), clockwise. A click will be heard as power is turned on, but the spindle will not rotate until the knob is turned clockwise a little further. Speed will increase progressively the further the knob is turned.

Run for a total of 5 minutes during which time gradually increase spindle speed to its maximum. Run for at least 2 minutes at this speed before stopping the machine and disconnecting from the mains supply.

Check that all components are still secure and working freely and correctly. Check also to ensure the mountings are secure.

Repeat the procedure at the HIGH range setting

Should any adjustments be necessary, refer to the appropriate section under Settings and 'Adjustments' .

CAUTION:

NEVER attempt to change from HIGH to LOW range with the machine running.

B. STARTING UNDER NORMAL CONDITIONS (ref. Fig. 5)

1. Take all necessary precautions previously stated, and ensure the workpiece can rotate fully without obstruction.
2. Set the Speed Range control lever to HIGH or LOW as required.
3. Set the Forward/Off/Reverse (F/O/R) switch (C) on the main control panel, to the FORWARD position.
4. Engage or ensure the Auto Feed lever is dis-engaged, depending upon whether or not auto automatic feed is required.

IMPORTANT: This should ALWAYS be a deliberate, conscious action.

NOTE: If Auto feed is required, the Leadscrew Forward/Neutral/Reverse Lever should be set to FORWARD. If Auto feed is not required the lever may be set to Neutral. To do this, grasp the knurled handle and pull out against spring pressure. Holding the handle in this position, move the lever until the point, on its end, locates in the middle pit mark in the casing.

5. Proceed to start the machine as described in Section. A above.
6. If the machine is finished with or is to be left unattended, turn the F/O/R switch to the OFF position then disconnect from the mains supply.

CAUTION:

ALWAYS turn the machine OFF at the Forward/off/Reverse switch BEFORE attempting to change any settings or make any adjustments. This includes changing from High to Low range.

OPERATION

A. SIMPLE TURNING

Before starting the machine, as described above, it is imperative that the setup for the type of work to be carried out is fully checked.

The following notes are guidelines as to how to set up the lathe in order to carry out a simple turning operation.

ALWAYS plan your work. Have drawings or a plan on hand together with any measuring instruments you may require, such as micrometers/verniers/calipers etc.

Select a cutting tool that will produce the desired cut and mount it in the Tool Rest, with as little overhang as possible, securing it using three hex socket head screws in the manner shown in FIG.6. (Ideally, the overhang should be approx. 10mm but not more than 15mm for a straight tool).

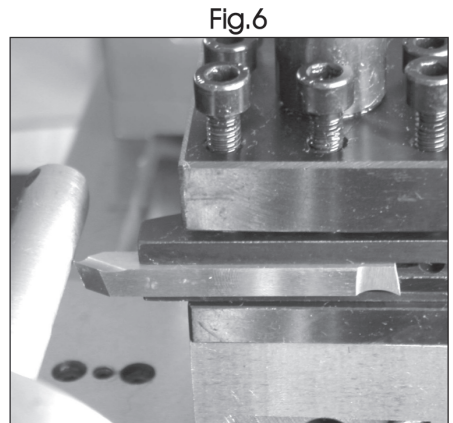

It is IMPORTANT to ensure that the tip of the cutting tool is on the centre line of the work, or very slightly below it. On no account should it be above the centre line.

Where necessary shims should be used beneath the tool in order to achieve the correct height, or, if the tip is too high, the only recourse is to select another tool or grind down the tip.

To check to ensure the tip is at the correct height, position the tool so that the tip is almost touching the point of the tailstock centre. They should coincide. If necessary make adjustments using shims, grind down the cutting tool tip or select another tool.

When satisfied, mount the work, either in the chuck or on a faceplate, and if necessary, use the tailstock centre for additional support (If the work cannot be adequately secured by the chuck, or if it is a long piece, or of small diameter). Additionally, 'Steadies' may be used which are described in greater detail under 'Accessories'.

If the Tailstock is not to be used, you may remove it completely by slackening off the securing nut at its base, and sliding it free of the bed.

Mark the surface of the work at the point where the cut is to end, i.e. the shoulder, using a scribe or similar means, and move the saddle so that the cutting tool is directly opposite the mark, then wind in the cross-slide so that the tool touches the surface of the work.

Whilst carrying out these manouvres, rotate the chuck by hand to ensure that nothing will come into contact with it when turning takes place, i.e. there is adequate clearance between the saddle, cross-slide, tool post or cutting tool. and the chuck.

it may be necessary to adjust the position of the compound slide or reposition the work in the chuck to guarantee that there is adequate clearance.

Fig.7

When satisfied retract the cutting tool and wind the saddle away from the headstock, then wind the cutting tool up to the work, somewhere along the length to be cut, whilst rotating the work by hand, using the chuck. Continue to advance the cutting tool slowly, until it just touches the surface. Record this position by zeroing the scale on the cross-slide, i.e. turn the moveable scale until the zero marks coincide, (see diagram opposite).

Once zeroed, retract the cross-slide one complete turn, then move the saddle until the tool is a short distance from the right hand edge of the Work. Wind in the cross-slide again one full turn until the zero marks again coincide.

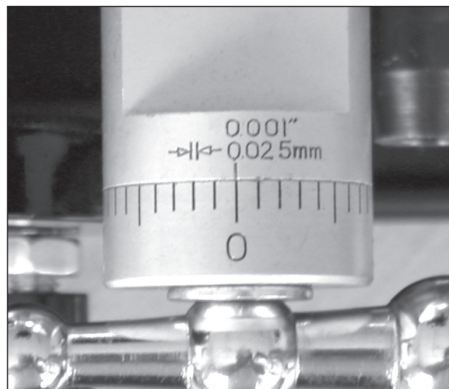

IMPORTANT: If you go past the zero marks, back off again at least one half of a turn, then slowly bring the marks back together.

Whenever you use the scale, as an indicator, to advance the cross-slide or compound slide, ALWAYS use this procedure to align the marks. This is to take into account backlash and other clearances in the gearing and slides etc.

Continue to turn the handle an amount equivalent to your desired depth of cut.

NOTE: We recommend that for rough cutting, you do not exceed 0.010"(0.25mm) as your depth of cut.

The setup is now complete to begin your cutting operation, but before starting, check the position of:

- a. Auto feed lever. Ensure it is in the UP position for manual feed.
- b. Forward/Neutral/Reverse leadscrew lever. If Auto feed is not required, set to 'Neutral'.
- c. HIGH/LOW lever. Select required speed range.

Switch the machine ON as described under 'Starting Procedure' and slowly feed the cutting tool into the work using the Manual Feed Handle. Proceed until you reach the previously marked line on the work, then retract the tool one or two complete turns on the Cross-Slide feed handle. Wind the saddle back to the beginning then wind the tool the same number of turns 'IN', plus the depth of desired cut, and proceed to cut once more.

NOTE: This describes the procedure for general, rough cutting. For other types of cuts - finishing, cutting shoulders etc., you should consult a suitable handbook.

B. SIMPLE TURNING WITH POWER FEED

The same basic setup is used as described above, except that, before starting, the Leadscrew F/N/R Lever (25) is set to the 'Forward' position and the Auto Feed Lever (13), is operated in order to drive the saddle.

As mentioned previously, the rotational speed of the leadscrew, and hence the rate of feed of the tool, is dependant upon the gear configuration of the gear train.

The feed rate for normal turning is considerably less than that used for screw cutting.

The lathe is factory configured for normal turning, however, if you have been screw cutting, always remember to reset the gear configuration to that for normal turning.

Please refer to the chart on later page which shows the gear configuration, and the explanation of how to change the gears on the same page.

1. Taking all precautions previously mentioned, position the cutting tool a short distance to the right of the workpiece with the appropriate depth of cut set on the cross-slide.
2. Ensure the leadscrew F/N/R lever is set to 'Forward' and select 'Forward' on the Forward/Off/Reverse switch on the main control panel. Switch on the machine.
3. Turn the knob to achieve your desired spindle speed with your right hand, push down on the auto feed lever until the nut becomes firmly engaged with the leadscrew.

IMPORTANT: Your left hand should always be free in order to hit the emergency stop should it become necessary.

4. Carefully observe the movement of the tool and as it approaches the mark on the surface, denoting the end of cut, pull the Auto Lever UP sharply and ensure it stays UP. If a degree of accuracy is required, it is recommended that you finish the cut by hand.

NOTE: If you require a shoulder with perfectly clean corners, then you need to use an appropriately shaped tool.

5. Retract the tool one or two complete turns on the cross-slide feed. then wind the saddle so that the tool is at the start point once again. Advance the tool the same number of turns, plus the depth of cut, and when ready, push down the auto feed lever and proceed to take another cut.

C. BEVEL CUTTING

Bevel cutting involves the use of the compound slide, which is mounted on the cross-slide and set at right angles to it for all normal cutting operations. This is indicated by the zero mark, on the scale, (B, Fig. 8), lining up with the mark etched on the body of the cross-slide.

To set the compound slide so that the cutting tool will cut a bevel, first retract the slide, until the two hex. socket head screws (A). are revealed as shown in Fig 9.

Slacken the screws sufficient to allow the compound slide to be turned to the desired angle, as indicated on the scale, and secure the slide in this position by retightening the hex. socket head screws.

The taper, or bevel, is cut by setting the cross-slide appropriately then using the compound slide feed handle to advance the cutting tool in the direction of the arrow as shown in Fig. 9.

Fig.8

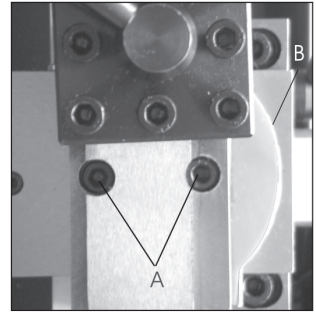
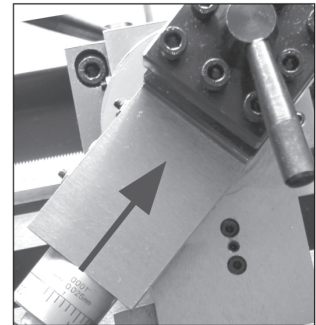

Fig.9



D. SCREWCUTTING

This operation requires a degree of skill and accuracy, and should not be attempted unless you are completely familiar with all aspects of the lathe.

Essentially, the saddle will move towards the headstock under power, the same as cutting using auto feed, except the rate of feed is greater, as determined by the gear configuration. The cutting tool therefore, is moving ever closer to the rotating chuck. Great care and concentration must be exercised to ensure that the two do not meet when the machine is operating, as the possible damage caused could be disastrous.

The lathe is supplied with a leadscrew that will produce Imperial Threads in a range from 12 to 52 threads per inch. or metric threads in a range from 0.4-2.0mm pitch. It is important to remember that the type of thread you need to cut, i.e. UNF, BA, BSP, BSW etc., will be totally dependant upon the cutting tool profile, as profiles differ from thread to thread.

For detailed information regarding screwcutting techniques, cutting tools etc., you should consult a suitable handbook or obtain advice from a qualified person.

The general procedure for screwcutting is as follows:

1. Try to get as much distance from the chuck to the end of the proposed screw thread as possible, and if your design allows, cut a 'run-off' into the workpiece which is of a smaller diameter than the root diameter of the proposed screw thread.
Note, that for long threads it may be necessary to use 'steady's' (see 'Accessories').
2. Install the appropriate gears for the thread required, and correctly mount the cutting tool. Set your required depth of cut, and position the tool ready to begin cutting.
Note, Depth of cut is vitally important and may be calculated or obtained from an appropriate reference manual.
3. Take all necessary precautions previously stated, and start the machine with the automatic feed lever in its' disengaged position (UP).
4. Engage the auto-feed lever sharply, turn the FORWARD/OFF/REVERSE (F/O/R) switch (C) to 'FORWARD'.

As the tool approaches the end of the desired thread, turn the switch (C) to 'OFF'. Do not disengage the auto-feed lever.

5. Retract the tool, using the cross-slide feed handle, noting the exact position on the scale and the exact number of turns.
Turn the switch (C) to 'REVERSE', the saddle winds back to the beginning and turn switch (C) to 'OFF'.
Reset the tool by winding IN the cross-slide the exact number of turns previously wound OUT and then continue to wind IN the to the desired depth of cut.
6. Repeat the step 4,5. Proceed in this manner until the thread is completed.

CHANGING GEARS FOR SCREWCUTTING

The leadscrew is driven, via a gear train, by a gear on the spindle. The gear ratio will therefore determine the rotational speed of the leadscrew with relation to the spindle. i.e. one turn of the spindle will turn the leadscrew an amount determined by the gear ratio.

By setting the gears to a known ratio, we can therefore produce threads to a known size, and as the leadscrew supplied produces Imperial threads, the known values will be in Threads Per Inch (TPI), or if the leadscrew supplied produces Metric threads, the known values will be in mm pitch.

As previously mentioned, the actual thread produced will be totally dependant upon the profile of the cutting tool. It is not within the scope of this manual to provide detailed information regarding types of cutting tool, cutting speeds and working with various types of material etc., and it is strongly advised that you consult appropriate handbooks or seek advice from a qualified person.

The chart below shows the thread sizes that may be cut using the gear configuration shown in the corresponding columns.

NOTE: The factory setup for the lathe provides for normal turning using the power or auto feed, and the gear configuration is as follows:

Gear A 20T
 Gear B 80T
 Gear C 20T
 Gear D 80T

Fig A

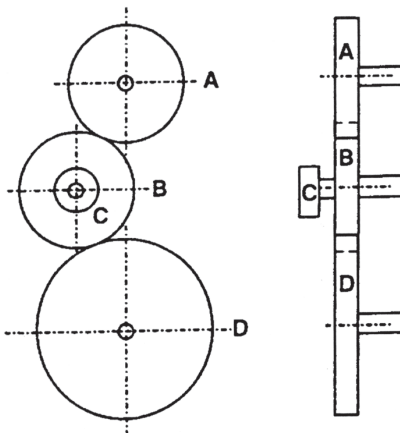
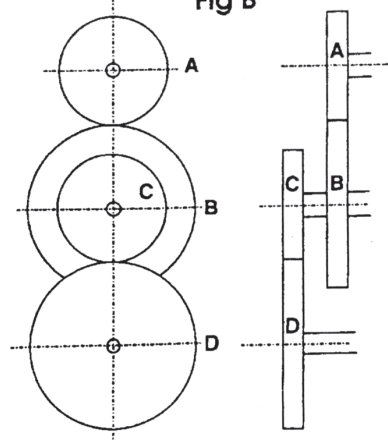

Fig B



GEAR CHART FOR CUTTING IMPERIAL THREADS

Threads Per Inch	Gear			
	A	B	C	D
12	40			30
13	40	65	60	30
14	40			35
16	40			40
18	40			45
19	40	50	60	57
20	40			50
22	40			55
24	40			60
26	40			65
28	20			35
32	20			40
36	20			45
38	20	50	50	57
40	20			50
44	20			55
48	20			60
52	20			65

Examples:

1. Ref. Fig A

To cut 12 TPI, use 40T in position A,
30T in position D,
and any convenient gear
in position B to connect A and D.

2. Ref. Fig B

To cut 13. TPI, use 40T in position A
65T in position B
60T in position C
30T in position D

GEAR CHART FOR CUTTING METRIC THREADS

mm 	Gear			
	A	B	C	D
0.4	20	50	40	60
0.5	20	50		60
0.6	40	50	30	60
0.7	40	50	35	60
0.8	40	50	40	60
1.0	20	60		30
1.25	50	40		60
1.5	40	60		40
1.75	35	60		30
2.0	40	60		30

Examples

1. Ref. Fig A

to cut 0.5mm/T. Use
20T in position A
50T in position B
60T in position D
and any convenient
gear in position C.

2. Ref. Fig B

to cut 0.4mm/T. Use
20T in position A
50T in position B
40T in position C
60T in position D

In order to change the gears, ensure the machine is switched OFF and disconnected from the mains supply.

Remove the gear train cover which is secured with two hex. socket head screws.

Gear A may be considered as the Driver, and Gear D as the Driven gear.

When a Simple gear train is configured, as illustrated in Fig. At the gear at B acts as an Idler and its size is therefore irrelevant - any convenient gear will suffice to connect A and D. This is denoted by a blank space in the column in the gear chart.

The positions of the shafts carrying gears A and D are fixed, therefore all adjustments are carried out on the shaft carrying gears B and C and the Adjuster 'A', shown in fig. 10.

1. Unscrew the hex socket head screws, securing gears A and D, followed by the screw securing gears B and C.
2. To allow the gears B and C to disengage completely and to provide for easier reassembly, unscrew the nut securing the shaft carrying B and C, and the nut securing the adjuster A.
3. Remove the gears, taking care to retain the small keys on each shaft, and replace with those necessary to produce your screw thread. They may be mounted either way round.
The number of teeth on each gear is clearly marked.
Replace the securing screws, ensuring the flat washer bears up against the gear hub in each case.

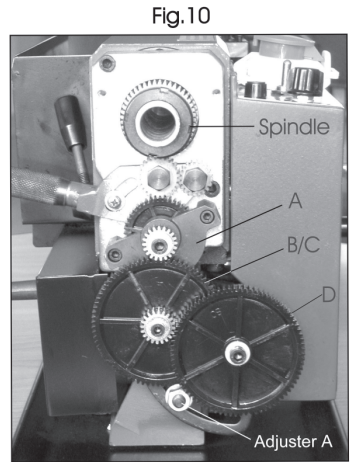

NOTE: If a compound gear train is required, as shown in Fig. B ensure the spacer, which is keyed to the shaft carrying gear D, is located on the shaft. BEFORE the gear, in order to align gear D with gear C.

4. Proceed to move the shaft carrying B and C and the adjuster 'A' so that all gears mesh correctly, then tighten the adjuster securing nuts. This may take one or two attempts but make sure there is as little backlash as possible without being overtight. (Turn the spindle by hand to test for backlash).

Replace the cover and secure with the two hex socket head bolts.

MAINTENANCE

For maximum performance, it is essential that the lathe is properly maintained.

BEFORE USE

Always inspect before use. Any damage should be repaired and maladjustments rectified. Damage to machined surfaces should be repaired with an oil stone. Test by hand to ensure smooth operation of all parts before use.

Inject a few drops of oil to the oilways at both leadscrew bearings (each end bracket) and once or twice during the day if used continuously. It will be necessary to remove the gear train cover in order to oil the left hand bearing.

Inject a few drops also to the compound slide oilway, located on the slides' top surface, between the two hex socket head screws.

AFTER USE

Remove all swarf from the machine and thoroughly clean all surfaces. If coolant has been used, ensure it has completely drained from the tray. Components should be dry, and all machined surfaces should be lightly oiled. Always remove cutting tools, and store in a safe place.

MOTOR BRUSHES

The Motor brushes may be changed by un-screwing the caps, visible at the front and rear of the machine, beneath the Headstock, as shown in Fig. 11.

Fig.11

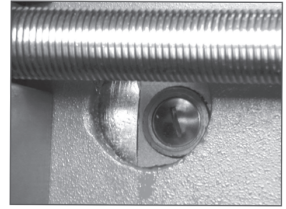

SETTINGS AND ADJUSTMENTS

Occasionally, it may be necessary to readjust various components in order to maintain optimum performance. The adjustments that may be performed are as follows:

A. CROSS-SLIDE ADJUSTMENTS

The cross-slide is mounted on a dovetail slide, as shown in fig. 12. Between the sloping surfaces on one side of the dovetail, a 'jib strip' is inserted, which may be tightened against the dovetail under the influence of three adjuster, or 'jib' screws, mounted along its' length.

The jib screws are to be found on the right hand side of the slide, directly beneath the compound slide handle. In time, wear will occur on the mating surfaces resulting in a 'sloppiness' of action.

To adjust the jib strip, to account for wear and ensure the slide moves evenly and smoothly, proceed as follows:

1. Slacken off all lock nuts and screw in the jib screws evenly, i.e. use the same torque for each screw. The slide should be held firmly. Test by trying to turn the handle, but do not force it.
2. Screw out each jib screw by one quarter of a turn ONLY, and nip up the lock nuts
3. Test again, by turning the handle. The movement should be even and smooth along its complete length.
4. If the movement is too slack, screw all adjusters 'in' by one eighth of a turn, and re-try. Similarly, if the movement is too stiff, screw 'out' the adjusters by one eighth of a turn until the correct adjustment is attained.
5. Tighten all lock nuts taking care to ensure you do not move the jib screws whilst doing so.
6. When completed. retract the slide fully and apply oil to all mating surfaces and the feed screw thread, then wind the slide back to its normal position.

Fig. 12

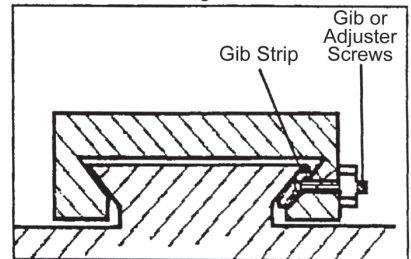

B. CROSS-SLIDE FEED HANDLE

The cross slide feed should run smoothly, and the scale must rotate with the handle.

If any stiffness occurs, it is probably the result of swarf lodging between the mating surfaces. Undo the securing hex socket head screw securing the handle. Remove the handle and pull off the collar with the scale taking great care to retain the small spring plate which sits in a groove beneath the collar.

Clean the assembly and reassemble in reverse order. It will be necessary to hold the spring plate in place with a small screwdriver, or similar tool, and pushing down on it to allow the collar to be correctly located on to the shaft.

C. COMPOUND SLIDE ADJUSTMENTS

Compound slide adjustments are made in the same way as those for the cross-slide. The jib screws are to be found on the left hand side of the slide, i.e facing the front of the lathe.

NOTE:

It is important that the cross-slide and compound slide adjustments are correctly carried out and that there is no 'sloppiness' of action. Any misadjustments will have a serious effect on the quality of your work, as they will all be transferred to the tool tip. It is vital that there is as little movement of the tool as possible.

ACCESSORIES

A range of accessories is available from your versatility of your machine. These are as follows:

Fig. 13

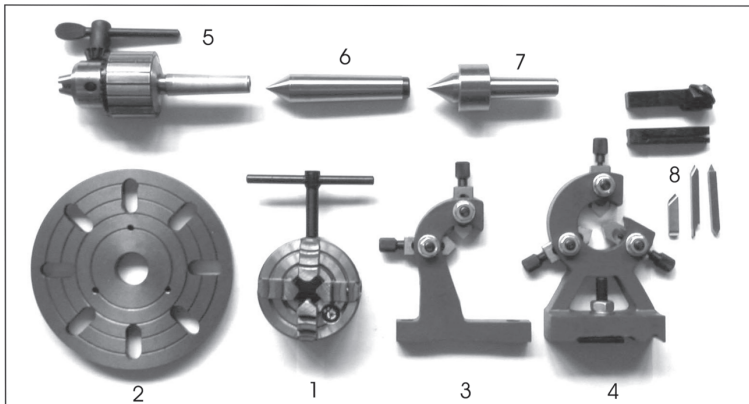

1. Independent 4-Jaw Chuck 80mm dia.
2. Face Plate - 160mm dia
3. Moving Steady
4. Fixed Steady
5. Tailstock Drilling Chuck with a 13 mm capacity.
6. Headstock Centre (MT3)
7. Revolving Centre (Tailstock - MT2)
8. 6 Piece Cutting Tool Set.
Comprising tools for 60 thread cutting,
parting/grooving, facing and general turning work.
(Hex. wrench not shown)
9. Thread Dial indicator (not shown)
(Imperial or Metric)

External Jaws 3-Jaw Chuck

To change the jaws, insert the chuck key and open the jaws to their fullest extent. It will then be possible to remove each jaw in turn.

Replace them with the external jaws, noting the following.

The thread segments of the jaws are progressively 'stepped' as shown in fig 14. They are also numbered 1 to 3. This is to take into account the lead of the screwthread within the chuck. It is therefore necessary to assemble the jaws in the correct order.

Fig.14



Place them as shown in the fig. 14, and assemble in the same order, clockwise in the slots in the chuck, turning the chuck key as you insert them. Close the jaws fully and check to ensure they all meet at the centre. If a jaw is out, open the jaws fully, and retain pressure on the jaw in question whilst turning the chuck key, until it snaps down into position. Re-check to ensure all jaws meet at the centre.

Fixed and Moving Steadies

Fig 15, illustrates the Fixed Steady (A) and Moving Steady (B) assembled to the lathe, used to support a long workpiece

Fig.15

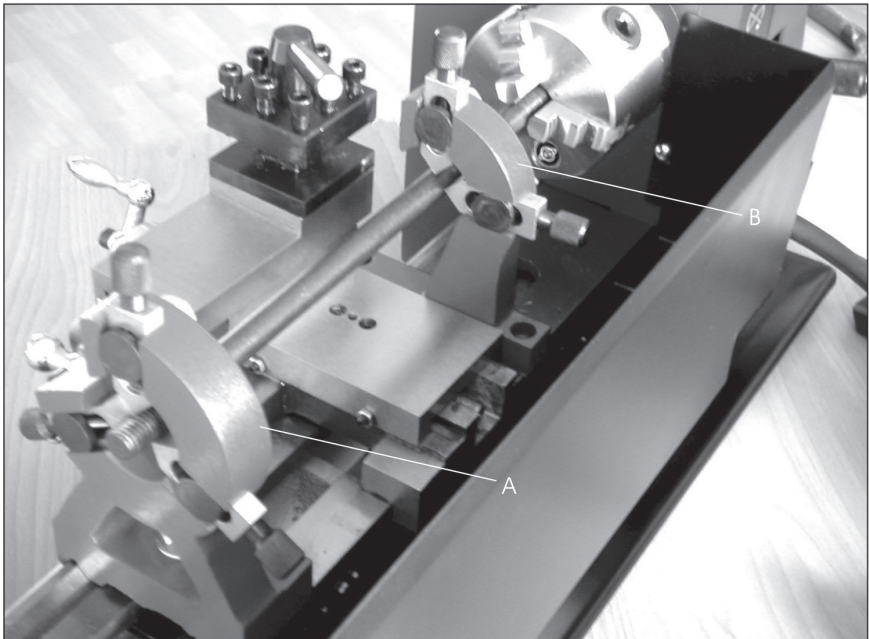

How to use a Thread Dial indicator

Mounted on the Apron, adjacent to the Auto Feed Lever, is the Thread Dial Indicator, shown in fig. 15. This is permanently connected to the leadscrew and, as the leadscrew turns, the 'dial' spins. Eight radial marks are etched on the dial and these are used to determine the exact position of the leadscrew thread in relation to the saddle.

The numbers in the 'SCALE' column refer to the numbers on the radial lines on the Indicator Dial. Therefore, if a 20TPI thread is to be cut for example, the marks 1,3,5 or 7 may be used. You should now proceed as follows:

1. Observe the spinning Dial. In particular, concentrate on one of the numbered marks etched on the dial which corresponds to the scale number given in the Indicator Table. (In our example, this could be 1,3,5 or 7) As your line passes the mark on the body of the dial indicator, engage the auto lever sharply and thread cutting will commence.
2. As the tool approaches the end of the desired thread, DISENGAGE THE AUTO FEED LEVER. Do not switch the machine OFF.
3. Retract the tool, using the cross-slide feed handle, noting the exact position on the scale and the exact number of turns. Wind the saddle back to the beginning and reset the tool by winding IN the cross-slide the exact number of turns previously wound OUT and then continue to wind IN to the desired depth of cut.
4. With the machine still running, observe the dial indicator and as the same numbered line, passes the mark on the body, engage the auto feed lever once again. Proceed in this manner until the thread is completed.

Engaging the auto feed lever as your predetermined line on the dial passes the mark on the body ensures the half nuts of the auto feed mechanism engage in the same thread on the leadscrew each time, thereby ensuring the cutting tool is in the same place for each pass which in turn produces a perfect thread.

Fig.15

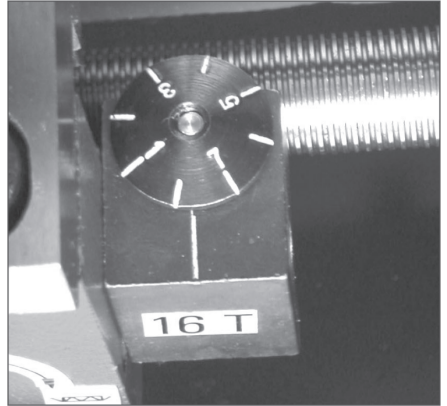

INDICATOR TABLE

TPI	SCALE	mm	
		Diagram	SCALE
12	1,3,5,7		
13	1		
14	1,5	0.4	1,3,5,7
16	1~8	0.5	1~8
18	1,5	0.6	1~8
19	1	0.7	1, 4,5
20	1,3,5,7	0.8	1,5
22	1,5	1.0	1~8
24	1~8	1.25	1, 3,5
26	1,5	1.5	1~8
28	1,3,5,7	1.75	1, 4,5
32	1~8	2.0	1~8
36	1,3,5,7		
38	1,5		
40	1~8		
44	1,3,5,7		
48	1~8		
52	1,3,5,7		

IMPERIAL

METRIC

- ie.
 1. 0.5mm/T, 0.6mm/T, 1mm/T,
 1.5mm/T or 2mm/T=1~8
 2. 1.25mm/T=1, 3,5
 3. 0.7mm/T, 1.75mm/T=1, 4,5
 4. 0.4mm/T=1, 3, 5, 7
 5. 0.8mm/T=1, 5

CONTACTS

Draper Tools Limited, Hursley Road,
Chandler's Ford, Eastleigh, Hampshire. SO53 1YF. U.K.

Delta International BV, Oude Graaf 8, 6002 NL, Weert, Netherlands

Helpline: (023) 8049 4344

Sales Desk: (023) 8049 4333

Internet: drapertools.com

E-mail: sales@drapertools.com

General Enquiries: (023) 8026 6355

Service/Warranty Repair Agent:

For aftersales servicing or warranty repairs, please contact the
Draper Tools Helpline for details of an agent in your local area.

YOUR DRAPER STOCKIST

RDMC0922

©Published by Draper Tools Limited.

No part of this publication may be reproduced, stored in a retrieval system or transmitted in any form or by any means, electronic, mechanical photocopying, recording or otherwise without prior permission in writing from Draper Tools Ltd.