



**DRAPER**®

# 16" DESK FAN

09111



These instructions accompanying the product are the original instructions. This document is part of the product, keep it for the life of the product passing it on to any subsequent holder of the product. Read all these instructions before assembling, operating or maintaining this product.

This manual has been compiled by Draper Tools describing the purpose for which the product has been designed, and contains all the necessary information to ensure its correct and safe use. By following all the general safety instructions contained in this manual, it will ensure both product and operator safety, together with longer life of the product itself.

All photographs and drawings in this manual are supplied by Draper Tools to help illustrate the operation of the product.

Whilst every effort has been made to ensure the accuracy of information contained in this manual, the Draper Tools policy of continuous improvement determines the right to make modifications without prior warning.

# 1. TITLE PAGE

---

## 1.1 INTRODUCTION:

**USER MANUAL FOR: 16" Desk Fan**

**Stock No: 09111**

**Part No: FAN16**

## 1.2 REVISIONS:

**Date first published February 2018.**

---

---

---

---

As our user manuals are continually updated, users should make sure that they use the very latest version.

**Downloads are available from:** <http://drapertools.com/manuals>

Draper Tools Limited  
Hursley Road  
Chandler's Ford  
Eastleigh  
Hampshire  
SO53 1YF  
UK

**Website:** [drapertools.com](http://drapertools.com)

**Product Helpline:** +44 (0) 23 8049 4344

**General Fax:** +44 (0) 23 8026 0784

## 1.3 UNDERSTANDING THIS MANUALS SAFETY CONTENT:

**WARNING!** – Information that draws attention to the risk of injury or death.

**CAUTION!** – Information that draws attention to the risk of damage to the product or surroundings.

## 1.4 COPYRIGHT © NOTICE:

Copyright © Draper Tools Limited.

Permission is granted to reproduce this publication for personal and educational use only. Commercial copying, redistribution, hiring or lending is prohibited.

No part of this publication may be stored in a retrieval system or transmitted in any other form or means without written permission from Draper Tools Limited.

In all cases this copyright notice must remain intact.

---

## 2. CONTENTS

---

<b>1. TITLE PAGE</b>	
1.1 INTRODUCTION.....	2
1.2 REVISION HISTORY .....	2
1.3 UNDERSTANDING THIS MANUAL .....	2
1.4 COPYRIGHT NOTICE .....	2
<b>2. CONTENTS</b>	
2.1 CONTENTS .....	3
<b>3. GUARANTEE</b>	
3.1 GUARANTEE .....	4
<b>4. INTRODUCTION</b>	
4.1 SCOPE.....	5
4.2 SPECIFICATION .....	5
4.3 HANDLING & STORAGE.....	5
<b>5. HEALTH AND SAFETY INFORMATION</b>	
5.1 GENERAL SAFETY INSTRUCTIONS FOR POWER TOOL USE .....	6-7
5.2 ADDITIONAL SAFETY INSTRUCTIONS FOR FANS.....	7
5.3 CONNECTION TO THE POWER SUPPLY.....	7
<b>6. TECHNICAL DESCRIPTION</b>	
6.1 IDENTIFICATION .....	8
<b>7. UNPACKING AND CHECKING</b>	
7.1 PACKAGING .....	9
<b>8. ASSEMBLING THE FAN</b>	
8.1 ASSEMBLING THE BASE .....	10
8.2 ASSEMBLING THE PROTECTIVE BLADE GRILLES.....	10
<b>9. FAN INSTRUCTION</b>	
9.1 SWITCH OPERATION .....	11
9.2 AIR FLOW DIRECTION .....	11
9.3 CLEANING INSTRUCTIONS .....	11
<b>10. EXPLANATION OF SYMBOLS</b>	
10.1 EXPLANATION OF SYMBOLS .....	12
<b>11. DISPOSAL</b>	
11.1 DISPOSAL.....	13
<b>DECLARATION OF CONFORMITY</b> .....	ENCLOSED

## 3. GUARANTEE

---

### 3.1 GUARANTEE

Draper tools have been carefully tested and inspected before shipment and are guaranteed to be free from defective materials and workmanship.

Should the tool develop a fault, please return the complete tool to your nearest distributor or contact:

**Draper Tools Limited, Chandler's Ford, Eastleigh, Hampshire, SO53 1YF. England.**

**Telephone Sales Desk: (023) 8049 4333** or:

**Product Helpline (023) 8049 4344.**

A proof of purchase must be provided.

If upon inspection it is found that the fault occurring is due to defective materials or workmanship, repairs will be carried out free of charge. This guarantee period covering parts/labour is 12 months from the date of purchase except where tools are hired out when the guarantee period is 90 days from the date of purchase. The guarantee is extended to 24 months for parts only. This guarantee does not apply to normal wear and tear, nor does it cover any damage caused by misuse, careless or unsafe handling, alterations, accidents, or repairs attempted or made by any personnel other than the authorised Draper warranty repair agent.

Note: If the tool is found not to be within the terms of warranty, repairs and carriage charges will be quoted and made accordingly.

This guarantee applies in lieu of any other guarantee expressed or implied and variations of its terms are not authorised.

Your Draper guarantee is not effective unless you can produce upon request a dated receipt or invoice to verify your proof of purchase within the guarantee period.

Please note that this guarantee is an additional benefit and does not affect your statutory rights.

**Draper Tools Limited.**

# 4. INTRODUCTION

---

## 4.1 SCOPE

The 16", 3 speed oscillating desk fan described in this booklet is intended for air flow circulation uses in home or office environments.

## 4.2 SPECIFICATION

Stock No. ....	09111
Part No. ....	FAN16
Motor:	
Rated voltage .....	230V
Rated frequency .....	50Hz
Rated input .....	45W
No. of speeds .....	3
Dimensions (WxHxD) .....	440 x 590 x 300mm
Weight (fan only) .....	2kg

## 4.3 HANDLING & STORAGE

This fan is designed to be moved to different locations. Ensure it is always operated on a firm and stable surface. Ensure that water and/or cleaning detergent does not enter the motor housing or switch mechanism.

## 5. HEALTH AND SAFETY INFORMATION

---

### 5.1 GENERAL SAFETY INSTRUCTIONS FOR POWER TOOL USE

When using any type of power tool there are steps that should be taken to make sure that you, as the user, remain safe.

Common sense and a respect for the tool will help reduce the risk of injury.

**Read the instruction manual fully.** Do not attempt any operation until you have read and understood this manual. Most important you must know how to safely start and stop this machine, especially in an emergency.

**Keep the work area tidy and clean.** Attempting to clear clutter from around the machine during use will reduce your concentration. Mess on the floor creates a trip hazard. Any liquid spilt on the floor could result in you slipping.

**Find a suitable location.** If the machine is bench mounted; the location should provide good natural light or artificial lighting as a replacement. Avoid damp and dust locations as it will have a negative effect on the machine's performance.

If the machine is portable; do not expose the tool to rain. In all cases do not operate power tools near any flammable materials.

**Beware of electric shock.** Avoid contact with earthed surfaces; because they can conduct electricity if there is an electrical fault with the power tool. Always protect the power cable and route it away from danger.

**Keep bystanders away.** Children, onlookers and passers by must be restricted from entering the work area for their own protection. The barrier must extend a suitable distance from the tool user.

**Unplug and house all power tools that are not in use.** A power tool should never be left unattended while connected to the power supply. They must be housed in a suitable location, away locked up and from children.

**Do not overload or misuse the tool.** All tools are designed for a purpose and are limited to what they are capable of doing. Do not attempt to use a power tool (or adapt it in any way) for an application it is not designed for. Select a tool appropriate for the size of the job. Overloading a tool will result in tool failure and user injury: This covers the use of accessories.

**Dress properly.** Loose clothing, long hair and jewellery are all dangerous because they can become entangled in moving machinery: This can also result in parts of body being pulled into the machine.

Clothing should be close fitted, with any long hair tied back and jewellery and neck ties removed. Footwear must be fully enclosed and have a nonslip sole.

**Move the machine as instructed.** If the machine is hand held, do not carry it by the power supply cable. If the product is heavy; employ a second or third person to help move it safely or use a mechanical device. Always refer to the instructions for the correct method.

**Maintain your tools correctly.** A well maintained tool will do the job safely. Replace any damaged or missing parts immediately with original parts from the manufacturer. As applicable; moving parts clean, oiled or greased; handles clean; and emergency devices working.

**Wait for the machine to stop.** Unless the machine is fitted with a safety brake; some parts may continue to move due to momentum. Wait for all parts to stop; then unplug it from the power supply before making any adjustments, carrying out maintenance operations or just finishing using the tool.

**Prevent unintentional starting.** Before plugging any machine in to the power supply, make sure the switch is in the OFF position. If the machine is portable; do not hold the machine near the switch and take care when putting the machine down; that nothing can operate the switch.

## 5. HEALTH AND SAFETY INFORMATION

---

**Carefully select an extension lead.** Some machines are not suitable for use with extension leads. When using an extended lead, select one capable of handling the current (amps) drawn by the machine in use. Fully extend the lead regardless of the distance between the power supply and the tool. Excess current (amps) and a coiled extension lead will both cause the cable to heat up and can result in fire.

**Concentrate and stay alert.** Distractions are likely to cause an accident. Never operate a power tool if you are under the influence of drugs (prescription or otherwise), including alcohol or if you are feeling tired. Being disorientated will result in an accident.

**Have this tool repaired by a qualified person.** This tool is designed to conform to the relevant international and local standards and as such should be maintained and repaired by someone qualified; using only original parts supplied by the manufacturer: This will ensure the tool remains safe to use.

### 5.2 ADDITIONAL SAFETY INSTRUCTIONS FOR FANS

**Warning:** Please read the following instructions carefully, failure to do so could lead to serious personal injury.

Draper Tools Ltd., recommends that this fan not be modified or used for any application other than that for which it was designed. If you are unsure of its relative applications, do not hesitate to contact us in writing and we will advise you.

- Keep out of the reach of children.
- Ensure fan is situated and used in an area free from loose furnishings, clothing, curtains etc that could get sucked in to the fan air inlet, or could block the fan blades.
- Do not leave the fan running unattended.
- Remove the plug from the socket before carrying out adjustment, servicing or maintenance.
- Complete any assembly procedures prior to connection to the power supply.
- Never insert fingers, pencils, or any other object through the protective grille, while the fan is running.
- Disconnect the fan from the power supply when moving it from one location to the other.
- Ensure the fan is switched off from the mains supply before removing the grille.
- Always complete the assembly of the fan before switching it on after cleaning.
- Always ensure the fan is secure on a firm and secure surface before operating.
- Do not use the fan near an open window, as rain can create an electrical hazard.
- If the power supply cable becomes damaged, it should be replaced immediately.
- If replacement of the supply cord is necessary, this should be carried out by the manufacturer or appropriate agent in order to avoid a safety hazard.
- Do not use this fan with a separate speed control device.

### 5.3 CONNECTION TO THE POWER SUPPLY

Make sure the power supply information on the machine's rating plate are compatible with the Power supply you intend to connect it to.

This fan comes supplied with a UK standard 3 pin plug. It is designed for connection to a Domestic power supply rated at 230V AC.

It is Class 2 (double insulated); is designed for connection to a power supply matching that detailed on the rating label and compatible with the plug fitted.

If an extension lead is required, use an approved and compatible lead rated for this appliance. Follow all the instructions supplied with the extension lead. If using an extension lead, follow the instructions that came with your lead regarding maximum load while cable is wound, if in doubt ensure that the entire cable is unwound. Using a coiled extension lead will generate heat which could melt the lead and cause a fire.

This product requires no earth connection as supplementary insulation is applied to the basic insulation to protect against electric shock in the event of failure to the basic insulation.

## 6. TECHNICAL DESCRIPTION

---

### 6.1 IDENTIFICATION

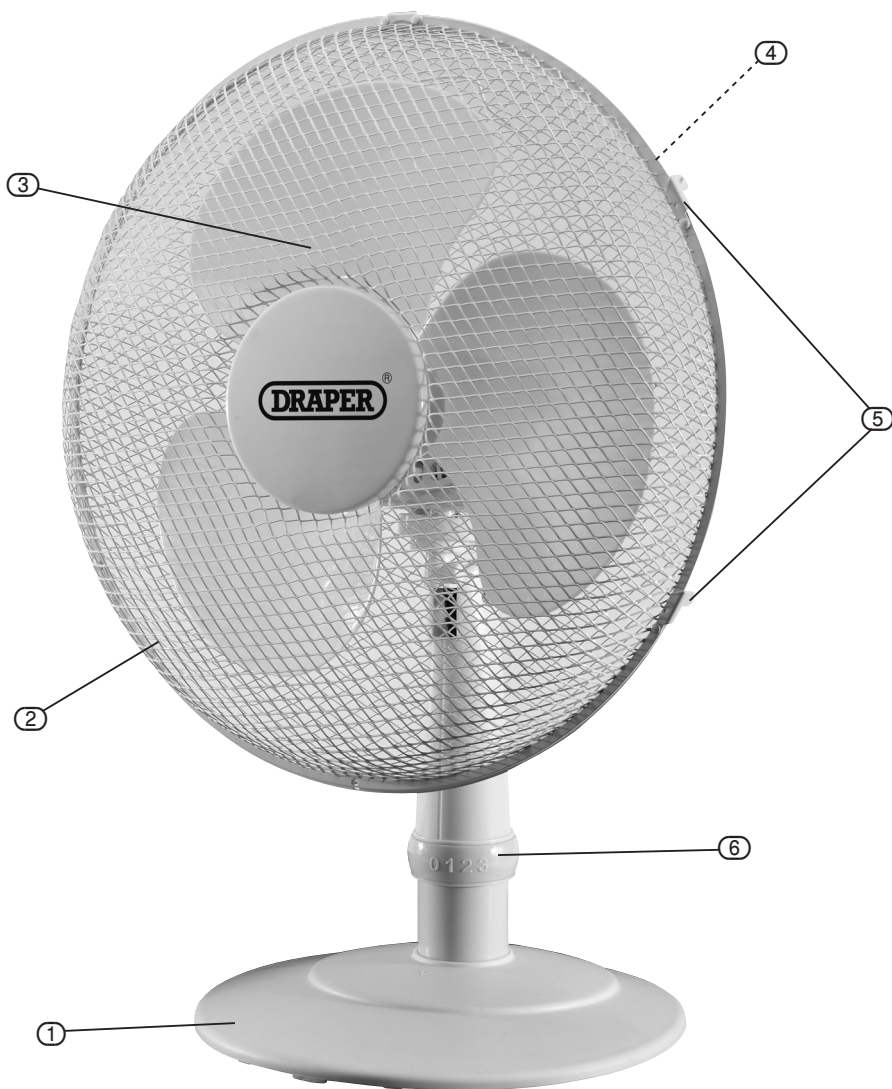

① Base.

② Front grille.

③ Fan blade.

④ Rear grille.

⑤ Clips.

⑥ Speed control collar.



# 7. UNPACKING AND CHECKING

## 7.1 PACKAGING

Carefully remove the machine from the packaging and examine it for any sign of damage that may have happened during shipping. Lay the contents out and check them against the parts shown below. If any part is damaged or missing; please contact the Draper Helpline (the telephone number appears on the Title page) and do not attempt to use the machine.

The packaging material should be retained at least during the guarantee period: in case the machine needs to be returned for repair.

**Warning!** Some of the packaging materials used may be harmful to children. Do not leave any of these materials in the reach of children.

If any of the packaging is to be thrown away, make sure they are disposed of correctly; according to local regulations..

## 7.2 WHAT'S IN THE BOX?

The packaging contains several parts and semi-assembled elements that require final assembly. Lay out the contents and check off the items against those featured below.

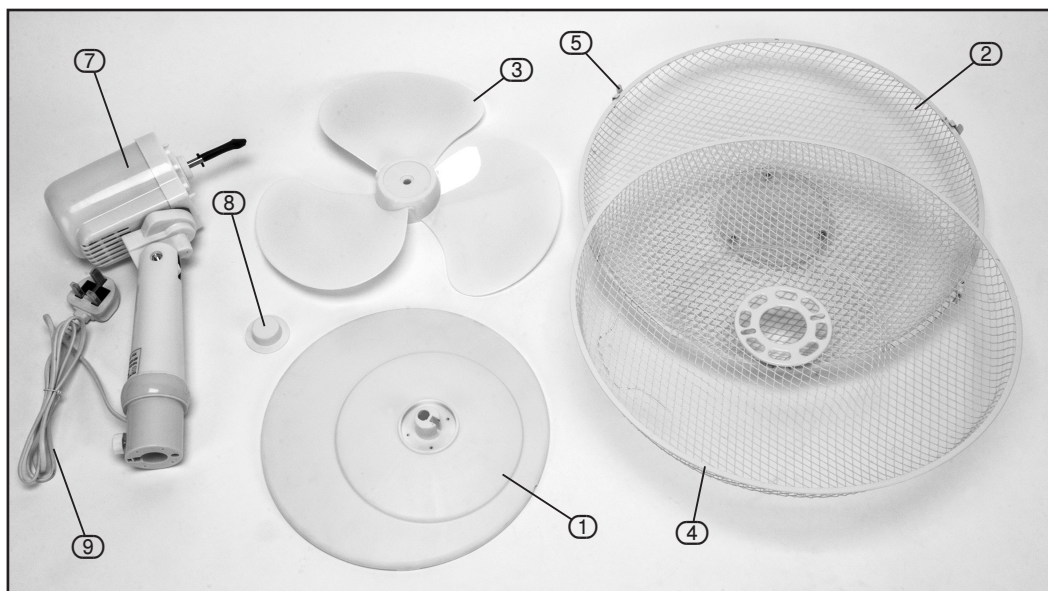

- |                 |               |
|-----------------|---------------|
| ① Base.         | ⑦ Fan body.   |
| ② Front grille. | ⑧ Clamp nut.  |
| ③ Fan blade.    | ⑨ Power lead. |
| ④ Rear grille.  |               |
| ⑤ Clips.        |               |

## 8. ASSEMBLING THE FAN

### 8.1 ASSEMBLING THE BASE

1. Align the fan body (7) with the base of the fan (1) ensuring the groove and nut are aligned.
2. To secure, using the threaded nut (7.1) on the fan body, tighten the assembled parts together.

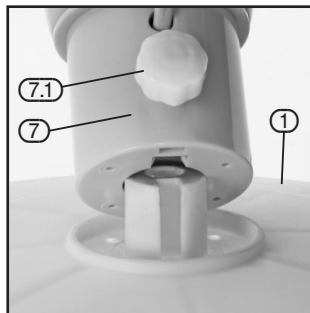

### 8.2 ASSEMBLING THE PROTECTIVE BLADE GRILLES

1. Remove plastic clamp nut (7.2) from motor.
2. Locate the rear grille (4) in the correct position (handle at top).
3. Tighten the plastic clamp nut (7.2) to secure the rear grille.
4. Discard the PVC sleeve on the motor shaft.
5. Slide the fan blade (3) onto the motor shaft until it reaches and aligns with the retaining pin.
5. Screw the clamp nut (8) to secure fan blade onto the motor shaft in an **anticlockwise** direction (reverse thread).
6. Undo the locking screw (5.1) mounted on the rear grille. Mount the front grille (2) onto the rear grille (4) ensuring that the small round hole on the bottom aligns with the hole on the rear grille.
7. Fix both grilles together with the clips (5) and then tighten the locking (5.1) screw. Ensure all fixings are safe and secure **BEFORE** operating fan.

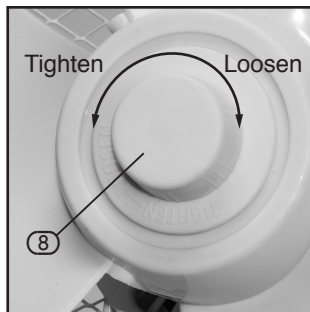
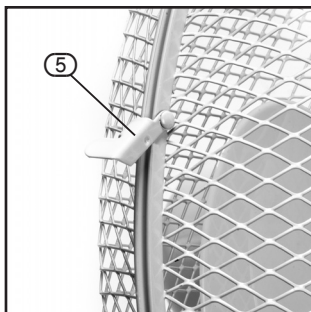
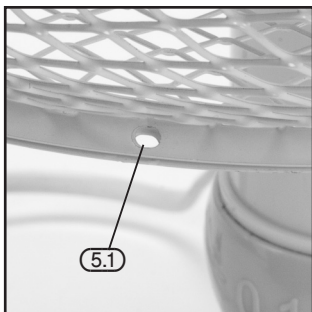
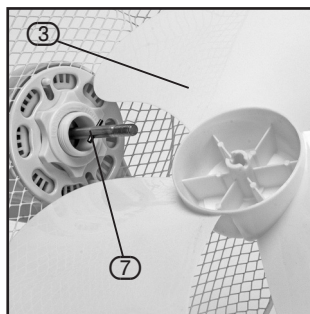
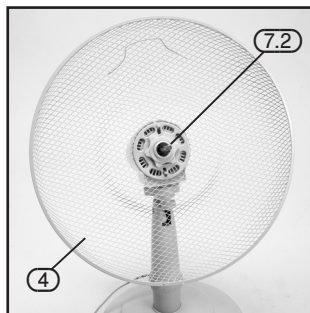

## 9. FAN INSTRUCTION

---

### 9.1 SWITCH OPERATION

The speed is controlled by rotating the collar on the fan:

- 0 OFF.
- 1 LOW.
- 2 MEDIUM.
- 3 HIGH.

**Important:** Remove the plug from the power supply and wait until the fan has completely stopped rotating before making any adjustments to it.



### 9.2 AIR FLOW DIRECTION

- 1. To start/stop the fan head oscillating, push down/pull up the oscillation action knob.
- 2. The air flow can be adjusted upward or downward by loosening the tilt adjustment knob and adjusting the vertical angle as desired. Re-tighten knob securely.

### 9.3 CLEANING INSTRUCTIONS

**Note:** Remove the plug from the socket before carrying out adjustment, servicing or maintenance.

**Warning:** Ensure that the fan is switched off from the mains and plug is disconnected from the power supply before removing the grille.

- 1. To disassemble the fan, reverse the sequence of the '8.1 assembling the protective blade grilles' section (page 11).
- 2. Clean components with a dry/damp soft cloth. **DO NOT** use detergents/sprays as these will damage the motor/switch assembly.

# 10. EXPLANATION OF SYMBOLS

---

## 10.1 EXPLANATION OF SYMBOLS



Do not dispose of WEEE\*  
unsorted municipal waste.



Class II construction  
(Double insulated).

# 12. DISPOSAL

---

## 12.1 DISPOSAL

- At the end of the machine's working life, or when it can no longer be repaired, ensure that it is disposed of according to national regulations.
- Contact your local authority for details of collection schemes in your area.

In all circumstances:

- Do not dispose of power tools with domestic waste.
- Do not incinerate.
- Do not abandon in the environment.
- Do not dispose of WEEE\* as unsorted municipal waste.



■  
\* Waste Electrical & Electronic Equipment.





# CONTACTS

Draper Tools Limited, Hursley Road,  
Chandler's Ford, Eastleigh, Hampshire. SO53 1YF. U.K.

Helpline: (023) 8049 4344

Sales Desk: (023) 8049 4333

Internet: [drapertools.com](http://drapertools.com)

E-mail: [sales@drapertools.com](mailto:sales@drapertools.com)

General Enquiries: (023) 8026 6355

**Service/Warranty Repair Agent:**

For aftersales servicing or warranty repairs, please contact the Draper Tools Helpline for details of an agent in your local area.

YOUR DRAPER STOCKIST

PJKC0218

©Published by Draper Tools Limited.

No part of this publication may be reproduced, stored in a retrieval system or transmitted in any form or by any means, electronic, mechanical photocopying, recording or otherwise without prior permission in writing from Draper Tools Ltd.