



**DRAPER**<sup>®</sup>

230V 3MM

# PLANER

57564



These instructions accompanying the product are the original instructions. This document is part of the product, keep it for the life of the product passing it on to any subsequent holder of the product. Read all these instructions before assembling, operating or maintaining this product.

This manual has been compiled by Draper Tools describing the purpose for which the product has been designed, and contains all the necessary information to ensure its correct and safe use. By following all the general safety instructions contained in this manual, it will ensure both product and operator safety, together with longer life of the product itself.

All photographs and drawings in this manual are supplied by Draper Tools to help illustrate the operation of the product.

Whilst every effort has been made to ensure the accuracy of information contained in this manual, the Draper Tools policy of continuous improvement determines the right to make modifications without prior warning.

# 1. TITLE PAGE

---

## 1.1 INTRODUCTION:

**USER MANUAL FOR: 230V 3MM Planer**

**Stock No: 57564**

**Part No: P900D82**

## 1.2 REVISIONS:

---

**Date first published January 2019.**

---

---

---

---

As our user manuals are continually updated, users should make sure that they use the very latest version.

**Downloads are available from:** <http://drapertools.com/manuals>

Draper Tools Limited

Hursley Road

Chandler's Ford

Eastleigh

Hampshire

SO53 1YF

UK

**Website:** [drapertools.com](http://drapertools.com)

**Product Helpline:** +44 (0) 23 8049 4344

**General Fax:** +44 (0) 23 8026 0784

## 1.3 UNDERSTANDING THIS MANUALS SAFETY CONTENT:

**WARNING!** – Information that draws attention to the risk of injury or death.

**CAUTION!** – Information that draws attention to the risk of damage to the product or surroundings.

## 1.4 COPYRIGHT © NOTICE:

Copyright © Draper Tools Limited.

Permission is granted to reproduce this publication for personal and educational use only. Commercial copying, redistribution, hiring or lending is prohibited.

No part of this publication may be stored in a retrieval system or transmitted in any other form or means without written permission from Draper Tools Limited.

In all cases this copyright notice must remain intact.

---

# 2. CONTENTS

---

<b>1. TITLE PAGE</b>	
1.1 INTRODUCTION.....	2
1.2 REVISION HISTORY .....	2
1.3 UNDERSTANDING THIS MANUAL .....	2
1.4 COPYRIGHT NOTICE .....	2
<b>2. CONTENTS</b>	
2.1 CONTENTS.....	3
<b>3. WARRANTY</b>	
3.1 WARRANTY.....	4
<b>4. INTRODUCTION</b>	
4.1 SCOPE.....	5
4.2 SPECIFICATION .....	5
4.3 HANDLING AND STORAGE.....	5
<b>5. HEALTH AND SAFETY INFORMATION</b>	
5.1 GENERAL SAFETY INSTRUCTIONS FOR POWER TOOL USE .....	6-7
5.2 SAFETY INSTRUCTIONS FOR PLANERS .....	7
5.3 RESIDUAL RISK .....	8
5.4 CONNECTION TO THE POWER SUPPLY.....	8
<b>6. TECHNICAL DESCRIPTION</b>	
6.1 IDENTIFICATION .....	9
<b>7. UNPACKING AND CHECKING</b>	
7.1 PACKAGING .....	10
7.2 WHAT'S IN THE BOX.....	10
<b>8. PREPARING THE PLANER</b>	
8.1 DUST COLLECTOR INSTALLATION.....	11
8.2 ADJUSTABLE CUTTING DEPTH .....	11
<b>9. BASIC PLANER OPERATION</b>	
9.1 ON/OFF SWITCH.....	12
9.2 GENERAL MACHINING.....	12
9.3 BEVEL EDGES .....	13
9.4 PLANING WITH THE GUIDE BAR .....	13
<b>10. OPTIONAL ACCESSORIES</b>	
10.1 OPTIONAL ACCESSORIES.....	13
<b>11. MAINTENANCE AND TROUBLESHOOTING</b>	
11.1 MAINTENANCE .....	14
11.2 BLADE REPLACEMENT.....	14
11.3 TRANSMISSION BELT REPLACEMENT .....	15
11.4 TROUBLESHOOTING .....	16
<b>12. DISPOSAL</b>	
12.1 DISPOSAL.....	17
<b>13. EXPLANATION OF SYMBOLS</b>	
13.1 EXPLANATION OF SYMBOLS .....	18
<b>DECLARATION OF CONFORMITY .....</b>	<b>ENCLOSED</b>

## 3. WARRANTY

---

### 3.1 WARRANTY

Draper tools have been carefully tested and inspected before shipment and are guaranteed to be free from defective materials and workmanship.

Should the tool develop a fault, please return the complete tool to your nearest distributor or contact:

**Draper Tools Limited, Chandler's Ford, Eastleigh, Hampshire, SO53 1YF. England.**

**Telephone Sales Desk: (023) 8049 4333 or:**

**Product Helpline (023) 8049 4344.**

A proof of purchase must be provided.

If upon inspection it is found that the fault occurring is due to defective materials or workmanship, repairs will be carried out free of charge. This warranty period covering labour is 12 months from the date of purchase except where tools are hired out when the warranty period is 90 days from the date of purchase. The warranty is extended to 24 months from the date of purchase for parts only. This warranty does not apply to any consumable parts, any type of battery or normal wear and tear, nor does it cover any damage caused by misuse, careless or unsafe handling, alterations, accidents, or repairs attempted or made by any personnel other than the authorised Draper warranty repair agent.

Note: If the tool is found not to be within the terms of warranty, repairs and carriage charges will be quoted and made accordingly.

This warranty applies in lieu of any other warranty expressed or implied and variations of its terms are not authorised.

Your Draper warranty is not effective unless you can produce upon request a dated receipt or invoice to verify your proof of purchase within the warranty period.

Please note that this warranty is an additional benefit and does not affect your statutory rights.

**Draper Tools Limited.**

# 4. INTRODUCTION

---

## 4.1 SCOPE

The electric planer is a tool that is designed for manual planing and edge bevelling of wood and other timber-derived materials.

As part of our core range, this product is suitable for enthusiasts and tradespeople alike. Any application other than that it was intended for, is considered misuse.

## 4.2 SPECIFICATION

Stock no.....	57564
Part no .....	P900D82
Rated voltage .....	230V~
Rated frequency .....	50Hz
Rated input .....	900W
Speed (no load) .....	16,000 rpm
Planing width .....	82mm
Planing depth .....	0 - 3mm
Rebating depth .....	0 - 15.5mm
Sound pressure level .....	91.2dB(A)
Sound power level .....	102.2dB(A)
Vibration level .....	4.130m/s <sup>2</sup> K=1.5m/s <sup>2</sup>
Weight (nett) .....	2.8kg

## 4.3 HANDLING AND STORAGE

- Care must be taken when handling this product.
  - Dropping this power tool could have an effect on its accuracy and could also result in personal injury. This product is not a toy and must be respected.
- Environmental conditions can have a detrimental effect on this product if neglected.
  - Exposure to damp air can gradually corrode components.
  - If the product is unprotected from dust and debris, components will become clogged.
  - If not cleaned and maintained correctly or regularly, the machine will not perform at its best.

## 5. HEALTH AND SAFETY INFORMATION

---

### 5.1 GENERAL SAFETY INSTRUCTIONS FOR POWER TOOL USE

When using any type of power tool there are steps that should be taken to make sure that you, as the user, remain safe.

Common sense and a respect for the tool will help reduce the risk of injury.

**Read the instruction manual fully.** Do not attempt any operation until you have read and understood this manual.

Most important you must know how to safely start and stop this machine, especially in an emergency.

**Keep the work area tidy and clean.** Attempting to clear clutter from around the machine during use will reduce your concentration. Mess on the floor creates a trip hazard. Any liquid spilt on the floor could result in you slipping.

**Find a suitable location.** If the machine is bench mounted, the location should provide good natural light or artificial lighting as a replacement. Avoid damp and dust locations as it will have a negative effect on the machine's performance. If the machine is portable do not expose the tool to rain. In all cases do not operate power tools near any flammable materials.

**Keep bystanders away.** Children, onlookers and passers by must be restricted from entering the work area for their own protection. The barrier must extend a suitable distance from the tool user.

**Unplug and house all power tools that are not in use.** A power tool should never be left unattended while connected to the power supply. They must be housed in a suitable location, away locked up and from children. This includes battery chargers.

**Do not overload or misuse the tool.** All tools are designed for a purpose and are limited to what they are capable of doing. Do not attempt to use a power tool (or adapt it in any way) for an application it is not designed for. Select a tool appropriate for the size of the job. Overloading a tool will result in tool failure and user injury: This covers the use of accessories.

**Dress properly.** Loose clothing, long hair and jewellery are all dangerous because they can become entangled in moving machinery: This can also result in parts of body being pulled into the machine. Clothing should be close fitted, with any long hair tied back and jewellery and neck ties removed. Footwear must be fully enclosed and have a non-slip sole.

**Wear personal protective equipment (PPE).** Dust, noise, vibration and swarf can all be dangerous if not suitably protected against. If the work involving the power tool creates dust or fumes wear a dust mask. Vibration to the hand, caused by operating some tools for longer periods must be protected against. Wear vibration reducing gloves and allow long breaks between uses. Protect against dust and swarf by wearing approved safety goggles or a face shield. These are some of the more common hazards and preventions, however, always find out what hazards are associated with the machine/work process and wear the most suitable protective equipment available.

**Do not breathe contaminated air.** If the work creates dust or fumes connect the machine (if possible) to an extraction system either locally or remotely. Working outdoors can also help if possible.

**Move the machine as instructed.** If the machine is hand held, do not carry it by the power supply cable. If the product is heavy, employ a second or third person to help move it safely or use a mechanical device. Always refer to the instructions for the correct method.

**Do not overreach.** Extending your body too far can result in a loss of balance and you falling. This could be from a height or onto a machine and will result in injury.

**Maintain your tools correctly.** A well maintained tool will do the job safely. Replace any damaged or missing parts immediately with original parts from the manufacturer. As applicable, keep blades sharp, moving parts clean, oiled or greased, handles clean and emergency devices working.

**Wait for the machine to stop.** Unless the machine is fitted with a safety brake, some parts may continue to move due to momentum. Wait for all parts to stop, then unplug it from the power supply before making any adjustments, carrying out maintenance operations or just finishing using the tool.

## 5. HEALTH AND SAFETY INFORMATION

---

**Remove and check setting tools.** Some machinery requires the use of additional tools or keys to set, load or adjust the power tool. Before starting the power tool always check to make certain they have been removed and are safely away from the machine.

**Prevent unintentional starting.** Before plugging any machine in to the power supply, make sure the switch is in the OFF position. If the machine is portable, do not hold the machine near the switch and take care when putting the machine down, that nothing can operate the switch.

**Carefully select an extension lead.** Some machines are not suitable for use with extension leads. If the tool is designed for use outdoors, use an extension lead also suitable for that environment. When using an extended lead, select one capable of handling the current (amps) drawn by the machine in use. Fully extend the lead regardless of the distance between the power supply and the tool. Excess current (amps) and a coiled extension lead will both cause the cable to heat up and can result in fire.

**Concentrate and stay alert.** Distractions are likely to cause an accident. Never operate a power tool if you are under the influence of drugs (prescription or otherwise), including alcohol or if you are feeling tired. Being disorientated will result in an accident.

**Have this tool repaired by a qualified person.** This tool is designed to conform to the relevant international and local standards and as such should be maintained and repaired by someone qualified, using only original parts supplied by the manufacturer. This will ensure the tool remains safe to use.

### IMPORTANT

**If using an extension lead, follow the instructions that came with your lead regarding maximum load while cable is wound. If in doubt, ensure that the entire cable is unwound. Using a coiled extension lead will generate heat which could melt the lead and cause a fire.**

## 5.2 SAFETY INSTRUCTIONS FOR PLANERS

### PERSONAL SAFETY

**Wait until the cutting shaft has completely stopped before placing down.** Naked blades may catch on the work surface, which may lead to uncontrolled movement of the tool and could result in serious injuries.

**Never put your hands into the dust extraction vent.** Rotating parts present a risk of injuries.

**Start the tool prior to applying blades to the material.** Risk of unexpected movements as the tool may be seized in the material.

**Always hold the machine flat so that the plates fully rest on the machined material.** The plane will become tilted and could cause personal injury.

**Never work with materials that may contain metal parts, such as nails or screws.** This may lead to damage to the cutting shaft or blades themselves or lead to excessive vibrations.

**Secure the object to be machined.** Make sure all clamps are closed and check for excessive clearance. It is safer to fix the object in a clamp or vice than holding in your hand.

**Do not use the tool if the power cord is damaged. Do not touch the power cord when damaged. If the power cord becomes damaged during operation unplug from the mains immediately.** Damaged power cords increase the risk of electric shock.

## 5. HEALTH AND SAFETY INFORMATION

---

### 5.3 RESIDUAL RISK

**Important note:** Although the safety instructions and operating manuals for our tools contain extensive instructions for safe working with power tools, every power tool involves a certain residual risk which can not be completely excluded by safety mechanisms. Power tools must therefore always be operated with caution!

### 5.4 CONNECTION TO THE POWER SUPPLY

**Caution:** Risk of electric shock. Do not open.

This appliance is supplied with a moulded 3 pin mains plug for your safety. The value of the fuse fitted is marked on the pin face of the plug. Should the fuse need replacing, ensure the substitute is of the correct rating, approved to BS1362 and ASTA or BSI Kite marked.

ASTA 

BSI 

The fuse cover is removable with a small plain slot screwdriver. Ensure the fuse cover is replaced before attempting to connect the plug to an electrical outlet. If the cover is missing, a replacement must be obtained or the plug replaced with a suitable type.

If a replacement plug is to be fitted this must be carried out by a qualified electrician.

The damaged or incomplete plug, when cut from the cable should be disabled to prevent connection to a live electrical outlet.

This appliance is Class II<sup>†</sup> and is designed for connection to a power supply matching that detailed on the rating label and compatible with the plug fitted.

If an extension lead is required, use an approved and compatible lead rated for this appliance. Follow all the instructions supplied with the extension lead.

<sup>†</sup>*Double insulated : This product requires no earth connection as supplementary insulation is applied to the basic insulation to protect against electric shock in the event of failure of the basic insulation.*

### IMPORTANT

**If using an extension lead, follow the instructions that came with your lead regarding maximum load while cable is wound. If in doubt, ensure that the entire cable is unwound. Using a coiled extension lead will generate heat which could melt the lead and cause a fire.**



## 6. TECHNICAL DESCRIPTION

### 6.1 IDENTIFICATION

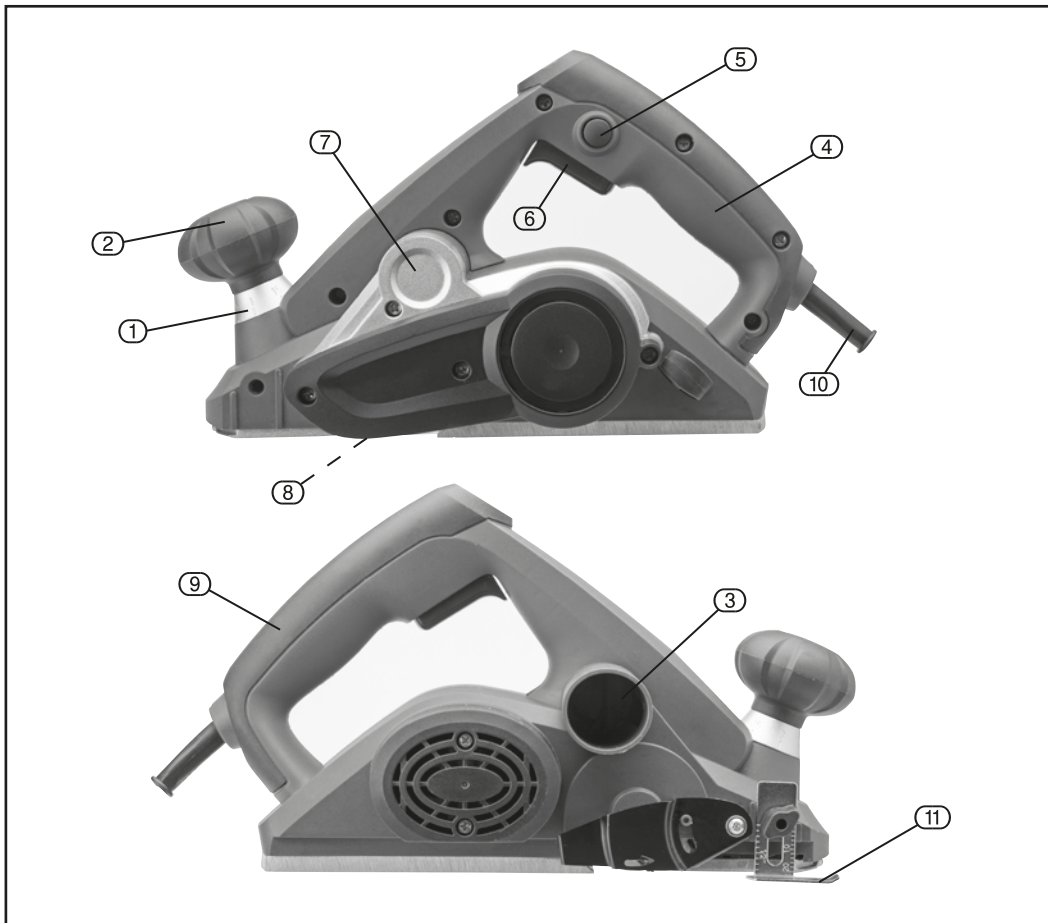

- ① Cutting depth scale.
- ② Cutting depth adjustment knob.
- ③ Dust extraction outlet.
- ④ Handle.
- ⑤ Safety lock button.
- ⑥ On/off trigger.

- ⑦ Transmission belt cover.
- ⑧ Blades.
- ⑨ Soft grip.
- ⑩ Moulded plug and cable.
- ⑪ Rebating depth guide.

# 7. UNPACKING AND CHECKING

---

## 7.1 PACKAGING

Carefully remove the product from the packaging and examine it for any sign of damage that may have happened during shipping. Lay the contents out and check them against the parts shown below. If any part is damaged or missing, please contact the Draper Help Line (the telephone number appears on the Title page) and do not attempt to use the product.

The packaging material should be retained at least during the guarantee period: in case the machine needs to be returned for repair.

### Warning!

- Some of the packaging materials used may be harmful to children. Do not leave any of these materials in the reach of children.
- If any of the packaging is to be thrown away, make sure they are disposed of correctly, according to local regulations.

## 7.2 WHAT'S IN THE BOX

As well as the main product, there are also several other parts not fitted or attached to it:

- ⑪ Rebating guide.
- ⑫ Guide bar.
- ⑬ Angle bracket for guide bar.
- ⑭ Dust collection bag.

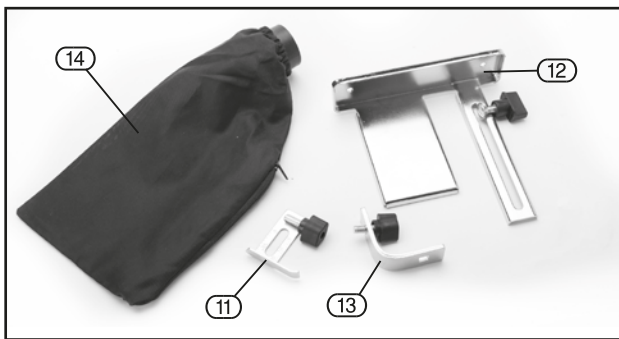

## 8. PREPARING THE PLANER

Remove the plug from the socket before carrying out adjustment, servicing or maintenance.

### 8.1 DUST COLLECTOR INSTALLATION - FIG. 1

Insert the dust collection bag (14) nozzle into the dust extraction outlet (3) as deep as possible.

**Warning:** Never put fingers into the dust extraction outlet. When the outlet is clogged, disconnect the tool from the power supply and remove the obstacle with a thin stick or compressed air.

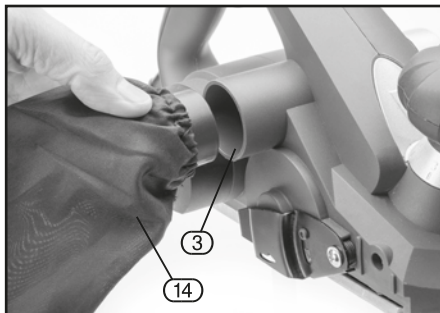

FIG.1

### 8.2 CUTTING DEPTH ADJUSTMENT - FIG. 2

The cutting depth adjustment knob (2) enables gradual changes to the cutting depth, ranging from 0 - 3mm, shown on the cutting depth scale (1). Anti-clockwise rotation reduces the depth, whilst clockwise rotation increases the depth.

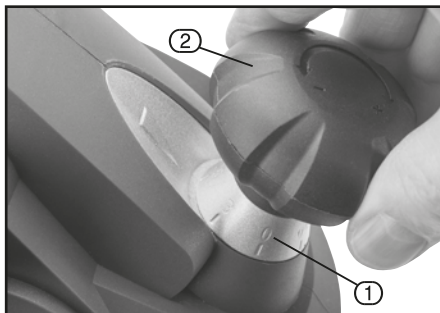

FIG.2

## 9. BASIC PLANER OPERATION

### 9.1 ON/OFF SWITCH - FIG. 3

Your planer is equipped with a safety locking button (5), which prevents accidental starting of the machine.

- To start the planer, first depress the locking button (5) and then push the on/off trigger (6).
- The trigger cannot be locked in the on position whilst operating the planer.
- Releasing the on/off trigger (6) switches the machine off.

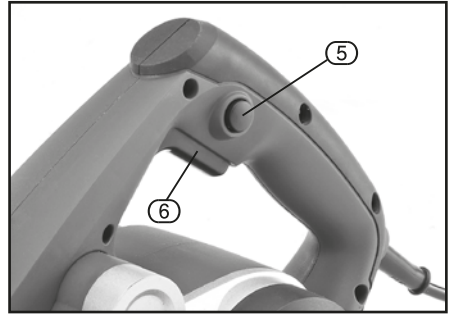

FIG.3

### 9.2 GENERAL MACHINING

- Set the desired cutting depth and place the front sole of the tool shoe onto the surface to be machined.

**Warning:** Only start planing after the tool reaches maximum speed. Risk of powerful kick backs prior to full speed.

- Switch the tool on and hold it with both hands. Move the planer smoothly and uniformly down the entire surface to be machined.

**Caution:** The power cord should always be kept within a safe distance from rotating parts of the tool.

- To achieve a high quality finish it is recommended to push the planer gently, equalising pressure on all areas of the planer shoe. For machining of hard materials, e.g. hard timber grades, or for planing with the entire width of the tool, it is recommended to only use a low cutting depth and reduce the speed of tool advancement.
- Advancing too quickly will reduce the quality of the finish, and may lead to the machine overloading or to quick clogging of the dust extraction outlet.
- Final finishing of surfaces should only be carried out with a small cutting depth and the surface is to be machined in multiple passes.

**Note:** When the cutter stalls, disconnect the tool from the power supply, remove the obstacle and check the condition of the blades. Never use the tool with damaged components.

## 9. BASIC PLANER OPERATION

---

### 9.3 BEVEL EDGES - FIG. 4

Fast and easy bevelling of edges is possible at the angle of 45° thanks to three dedicated V-shaped grooves (16) running down the front sole of the machine shoe. Place any of the grooves onto the machined edge and drive the tool forward. Pay attention to smooth and uniform movement and keep the angle constant for the best finished results.

**Note:** Only sharp cutting blades guarantee high quality of machining and prevent the tool from becoming damaged.

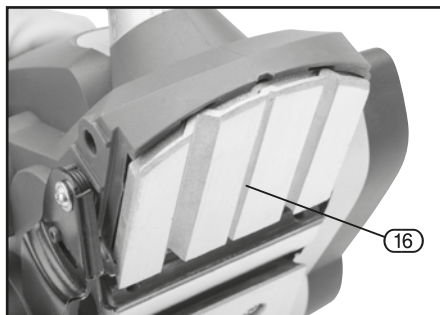

FIG.4

### 9.4 PLANING WITH THE GUIDE BAR - FIG. 5

Cutting out of recessed planes is easier with the use of the guide bar (12). The guide bar should be installed onto the tool with the angle bracket (13). To adjust the width of the planer it is necessary to release the nut, move the guide bar perpendicularly against the angle bracket to the desired width and then retighten the nut. The planer should be driven with a moderate lateral pushing force.

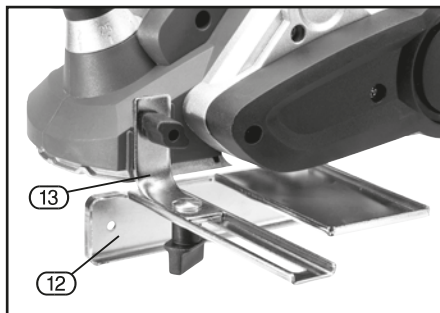

FIG.5

## 10. OPTIONAL ACCESSORIES

---

### 10.1 OPTIONAL ACCESSORIES

A full range of accessories are available from Draper Tools.

Please visit our website for details: [www.drapertools.com](http://www.drapertools.com)

# 11. MAINTENANCE AND TROUBLESHOOTING

## 11.1 MAINTENANCE

Regular inspection and cleaning reduces the necessity for maintenance operations and will keep your tool in good working condition. The motor must be correctly ventilated during tool operation. Avoid blocking the air inlets and vacuum the ventilation slots regularly.

## 11.2 BLADE REPLACEMENT - FIGS. 6 - 8

**Note:** Prior to commencing any maintenance or repair jobs, ensure that the device is disconnected from the power source.

**Note:** Worn, blunt or damaged cutters must be replaced with new ones.

**Caution:** When replacing the cutting blades wear protective gloves and be careful to avoid injury. Never directly touch the blades.

You can remove either just the blade alone or both the outer cover and the blade together. The new blade must be the same size and weight as the old one being replaced. Using different blades will cause the spindle to vibrate, the cutting quality will be poor and the tool may become damaged. To install the new blades:

- Loosen three fixing bolts (17) using the supplied spanner (Fig. 6).
- Once loose, hold the side guard down and push the blade out using a small piece of wood so as not to damage any of the metal parts on the cutter or holder (Fig. 7).
- Thoroughly clean the holder to remove any sawdust or debris.
- Install the new blade by sliding it into the holder.
- Tighten the three fixing bolts up just tight enough to locate the blade correctly.
- Using a straight edge (like a steel rule) check the blade setting by using the straight edge on the rear sole plate to check the level of the blade, adjust the two grub screws (18) using the supplied hex key until the blade is level and both blades have equal exposure (Fig. 8).

**Caution:** When mounting the blade on the spindle, the screws must be tight. Loose screws may result in personal injury. Always check that the screws are tight and that the blade is properly positioned before use. The blade edge and the sole must be parallel, otherwise the planed surface will not be flat and even. It is a good idea to occasionally swap the position of the blades to ensure even wear and best performance.



FIG.6

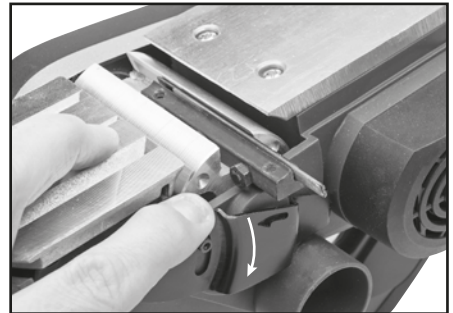

FIG.7

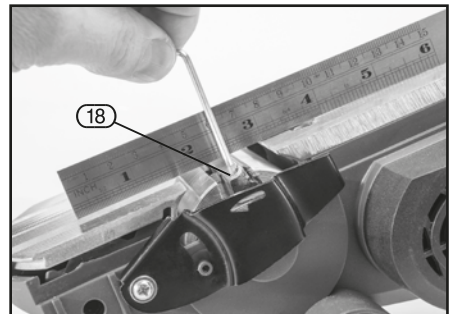

FIG.8

# 11. MAINTENANCE AND TROUBLESHOOTING

## 11.3 TRANSMISSION BELT REPLACEMENT - FIGS. 9 - 11

To replace the transmission belt proceed in the following way:

- Use a cross tip screwdriver (not supplied) to unscrew the two fixing bolts and remove the cover ⑦.
- Remove the damaged transmission belt.
- Clean the belt pulleys with a soft brush.
- Place the new belt on the groove of the smaller pulley and then rotate the larger pulley to drive the belt into its groove.

Take care to ensure that the belt is correctly located (Fig. 11).

- Reinstall the transmission belt cover and fix with the two cross head screws.

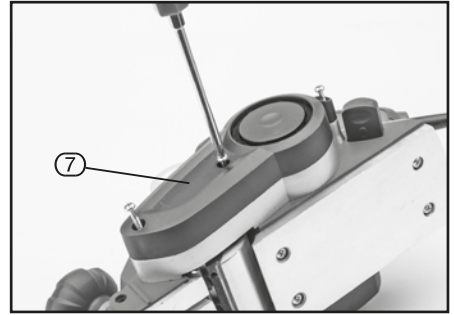

FIG.9

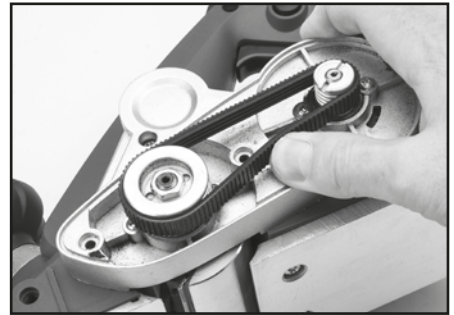

FIG.10

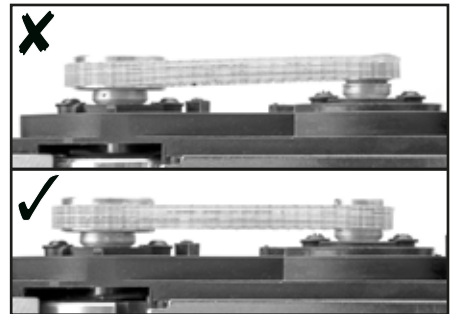

FIG.11

# 11. MAINTENANCE AND TROUBLESHOOTING

---

## 11.4 TROUBLESHOOTING

<b>Problems</b>	<b>Possible Causes</b>	<b>Remedy</b>
The tool fails to operate.	Blown fuse.	Check the power cable is connected correctly and check fuse. If the problem persists hand over the tool for repair at a service workshop.
Irregularities of the motor operation.	Worn carbon brushes of the motor.	Have the brushes replaced at a service workshop.
The cutting roller fails to rotate.	The transmission belt is worn/damaged.	Replace the belt.



# 12. DISPOSAL

---

## 12.1 DISPOSAL

- At the end of the machine's working life, or when it can no longer be repaired, ensure that it is disposed of according to national regulations.
- Contact your local authority for details of collection schemes in your area.

In all circumstances:

- Do not dispose of power tools with domestic waste.
- Do not incinerate.
- Do not dispose of WEEE\* as unsorted municipal waste.



\* *Waste Electrical & Electronic Equipment.*

# 13. EXPLANATION OF SYMBOLS

---

## 13.1 EXPLANATION OF SYMBOLS



Read the instruction manual.



Wear face mask and safety glasses.



Wear ear defenders.



WEEE –

Waste Electrical &  
Electronic Equipment.

*Do not dispose of Waste Electrical  
& Electronic Equipment in with  
domestic rubbish.*



# CONTACTS

Draper Tools Limited, Hursley Road,  
Chandler's Ford, Eastleigh, Hampshire. SO53 1YF. U.K.

Helpline: (023) 8049 4344

Sales Desk: (023) 8049 4333

Internet: [drapertools.com](http://drapertools.com)

E-mail: [sales@drapertools.com](mailto:sales@drapertools.com)

General Enquiries: (023) 8026 6355

**Service/Warranty Repair Agent:**

For aftersales servicing or warranty repairs, please contact the Draper Tools Helpline for details of an agent in your local area.

YOUR DRAPER STOCKIST

TACM0119

©Published by Draper Tools Limited.

No part of this publication may be reproduced, stored in a retrieval system or transmitted in any form or by any means, electronic, mechanical photocopying, recording or otherwise without prior permission in writing from Draper Tools Ltd.