



**DRAPER**<sup>®</sup>

**STORMFORCE**

20V 1/4" HEX.

# IMPACT DRIVER

89520



These instructions accompanying the product are the original instructions. This document is part of the product, keep it for the life of the product passing it on to any subsequent holder of the product. Read all these instructions before assembling, operating or maintaining this product.

This manual has been compiled by Draper Tools describing the purpose for which the product has been designed, and contains all the necessary information to ensure its correct and safe use. By following all the general safety instructions contained in this manual, it will ensure both product and operator safety, together with longer life of the product itself.

All photographs and drawings in this manual are supplied by Draper Tools to help illustrate the operation of the product.

Whilst every effort has been made to ensure the accuracy of information contained in this manual, the Draper Tools policy of continuous improvement determines the right to make modifications without prior warning.

# 1. TITLE PAGE

---

## 1.1 INTRODUCTION:

USER MANUAL FOR: 20V 1/4" Hex. Impact Driver

**Stock No's:** 89520

**Part No's:** CID20SF

## 1.2 REVISIONS:

---

**Date first published February 2018.**

---

---

---

---

As our user manuals are continually updated, users should make sure that they use the very latest version.

**Downloads are available from:** <http://drapertools.com/manuals>

Draper Tools Limited  
Hursley Road  
Chandler's Ford  
Eastleigh  
Hampshire  
SO53 1YF  
UK

**Website:** [drapertools.com](http://drapertools.com)

**Product Helpline:** +44 (0) 23 8049 4344

**General Fax:** +44 (0) 23 8026 0784

## 1.3 UNDERSTANDING THIS MANUALS SAFETY CONTENT:

**WARNING!** – Information that draws attention to the risk of injury or death.

**CAUTION!** – Information that draws attention to the risk of damage to the product or surroundings.

## 1.4 COPYRIGHT © NOTICE:

Copyright © Draper Tools Limited.

Permission is granted to reproduce this publication for personal and educational use only. Commercial copying, redistribution, hiring or lending is prohibited.

No part of this publication may be stored in a retrieval system or transmitted in any other form or means without written permission from Draper Tools Limited.

In all cases this copyright notice must remain intact.

---

# 2. CONTENTS

---

## 2.1 CONTENTS

### 1. TITLE PAGE

1.1 INTRODUCTION .....	1
1.2 REVISION HISTORY .....	2
1.3 UNDERSTANDING THIS MANUAL .....	2
1.4 COPYRIGHT NOTICE .....	2

### 2. CONTENTS

2.1 CONTENTS .....	3
--------------------	---

### 3. GUARANTEE

3.1 GUARANTEE .....	4
---------------------	---

### 4. INTRODUCTION

4.1 SCOPE .....	5
4.2 SPECIFICATION .....	5
4.3 HANDLING AND STORAGE .....	5

### 5. HEALTH AND SAFETY INFORMATION

5.1 GENERAL SAFETY INSTRUCTIONS FOR POWER TOOL USE .....	6
5.2 ADDITIONAL SAFETY INSTRUCTIONS FOR IMPACT DRIVERS .....	7
5.3 RESIDUAL RISK .....	8
5.4 SAFETY INSTRUCTIONS FOR MAINS POWERED BATTERY PACKS AND CHARGERS (sold separately) .....	8
<b>Chargers</b> .....	8
<b>Battery packs</b> .....	9
5.5 CONNECTION TO THE POWER SUPPLY (CHARGER (sold separately)) .....	9

### 6. TECHNICAL DESCRIPTION

6.1 IDENTIFICATION .....	10
--------------------------	----

### 7. UNPACKING AND CHECKING

7.1 PACKAGING .....	11
7.2 20V POWER INTERCHANGE BATTERY PACKS/CHARGERS .....	11

### 8. PREPARING THE IMPACT DRIVER

8.1 BATTERY PACK CHARGING .....	12
8.2 BATTERY PACK CHARGE STATUS .....	13
8.3 BATTERY PACK EFFICIENCY AND CHARGING ADVICE .....	13

### 9. BASIC OPERATION

9.1 INSTALLING AND REMOVING BITS .....	14
9.2 ROTATIONAL DRIVE SELECTION .....	14
9.3 VARIABLE SPEED TRIGGER .....	15
9.4 BELT CLIP .....	15
9.5 LED WORKLIGHT .....	15
9.6 BASIC OPERATION .....	16

### 10. MAINTENANCE & TROUBLESHOOTING

10.1 MAINTENANCE .....	17
10.2 TROUBLESHOOTING GUIDE .....	17

### 11. DISPOSAL

11.1 DISPOSAL .....	18
11.2 BATTERY PACK DISPOSAL INFORMATION .....	18

### 12. EXPLANATION OF SYMBOLS

12.1 EXPLANATION OF SYMBOLS .....	18
-----------------------------------	----

**DECLARATION OF CONFORMITY** ..... ENCLOSED

# 3. GUARANTEE

---

## 3.1 GUARANTEE

Draper tools have been carefully tested and inspected before shipment and are guaranteed to be free from defective materials and workmanship.

Should the tool develop a fault, please return the complete tool to your nearest distributor or contact:

**Draper Tools Limited, Chandler's Ford, Eastleigh, Hampshire, SO53 1YF. England.**

**Telephone Sales Desk: (023) 8049 4333 or:**

**Product Helpline (023) 8049 4344.**

A proof of purchase must be provided.

If upon inspection it is found that the fault occurring is due to defective materials or workmanship, repairs will be carried out free of charge. This guarantee period covering parts/labour is 6 months from the date of purchase except where tools are hired out when the guarantee period is 90 days from the date of purchase. The guarantee is extended to 24 months for parts only. This guarantee does not apply to normal wear and tear, nor does it cover any damage caused by misuse, careless or unsafe handling, alterations, accidents, or repairs attempted or made by any personnel other than the authorised Draper warranty repair agent.

Note: If the tool is found not to be within the terms of warranty, repairs and carriage charges will be quoted and made accordingly.

This guarantee applies in lieu of any other guarantee expressed or implied and variations of its terms are not authorised.

Your Draper guarantee is not effective unless you can produce upon request a dated receipt or invoice to verify your proof of purchase within the guarantee period.

Please note that this guarantee is an additional benefit and does not affect your statutory rights.

**Draper Tools Limited.**

# 4. INTRODUCTION

## 4.1 SCOPE

This cordless impact driver is designed for use with insert bits and sockets, intended for a variety of tasks where a high level of torque is required. It is intended for domestic use. Any other application is considered misuse.

This power product is supplied "naked"; without battery pack or charger. Draper 20V Power Interchange tools all use universal 2.0 and 4.0Ah batteries and chargers, enabling each battery to fit all tools within the range (see the table on page 11 for the batteries and chargers available).

## 4.2 SPECIFICATION

Stock No. ....	89520
Part No. ....	CID20SF
Batteries (sold separately):	
Stock No. ....	89437
Part No. ....	B202LISF
Type .....	Li-ion
Rated Voltage .....	20V
Rating .....	2.0Ah
Chargers (sold separately):	
Stock No. ....	89425
Part No. ....	CB20
Rated Voltage .....	230V~
Rated Frequency .....	50Hz
Rated D.C. Output Voltage .....	21.5V
Rated D.C. Output Current .....	2.4A
Protective device rated current .....	8A
Construction .....	Class II
Revolutions Per Minute (no load) .....	0 – 2800r/min
Drive spindle .....	1/4" Female Hex.
Maximum Torque .....	180Nm
Impact rate .....	0 - 3600bpm
Sound Pressure Level* .....	98.6dB(A), K=3 db(A)
Sound Power Level** .....	109.6dB(A), K=3 db(A)
Vibration Level .....	12.5m/s <sup>2</sup> , K=1.5 m/s <sup>2</sup>
Weight (machine only) .....	1.24kg

## 4.3 HANDLING & STORAGE

Although this product is small in size, care must still be taken when handling and lifting. Dropping this power tool will have an effect on the accuracy and may also result in personal injury. This product is not a toy and must be respected.

The environment can have a negative result on this product if not careful. Damp air can gradually corrode components. If the product is unprotected from dust and debris, components will become clogged. If not cleaned and maintained correctly or regularly, the machine will not perform at its best.

\* Continuous A-Weighted Sound Pressure Level at the workstation in accordance to prEN ISO 15744:1999 and declared according to EN ISO 4871.

\*\* A-Weighted Sound Power Level in accordance to prEN ISO 15744:1999 and declared according to EN ISO 4871.

# 5. HEALTH AND SAFETY INFORMATION

---

When using any type of power tool there are steps that should be taken to make sure that you, as the user, remain safe.

Common sense and a respect for the tool will help reduce the risk of injury.

## 5.1 GENERAL SAFETY INSTRUCTIONS FOR POWER TOOL USE



### Warning!

- Read all safety warnings and all instructions. Failure to follow the warnings and instructions may result in electric shock, fire and/or serious injury.

**Most important:** You must know how to safely start and stop this machine, especially in an emergency.

**Keep the work area tidy and clean.** Attempting to clear clutter from around the machine during use will reduce your concentration. Mess on the floor creates a trip hazard. Any liquid spilled on the floor could result in you slipping.

**Find a suitable location.** If the machine is bench mounted; the location should provide good natural light or artificial lighting as a replacement. Avoid damp and dust locations as it will have a negative effect on the machine's performance. If the machine is portable; do not expose the tool to rain. In all cases do not operate power tools near any flammable materials.

**Keep bystanders away.** Children, onlookers and passers by must be restricted from entering the work area for their own protection. The barrier must extend a suitable distance from the tool user.

Unplug and house all power tools that are not in use. A power tool should never be left unattended while connected to the power supply. They must be housed in a suitable location, away locked up and from children.

**Do not overload or misuse the tool.** All tools are designed for a purpose and are limited to what they are capable of doing. Do not attempt to use a power tool (or adapt it in any way) for an application it is not designed for. Select a tool appropriate for the size of the job. Overloading a tool will result in tool failure and user injury: This covers the use of accessories.

**Dress properly.** Loose clothing, long hair and jewellery are all dangerous because they can become entangled in moving machinery: This can also result in parts of body being pulled into the machine. Clothing should be close fitted, with any long hair tied back and jewellery and neck ties removed. Footwear must be fully enclosed and have a non-slip sole.

**Wear personal protective equipment (PPE).** Dust, noise, vibration and swarf can all be dangerous if not suitably protected against. If the work involving the power tool creates dust or fumes; wear a dust mask. Vibration to the hand, caused by operating some tools for longer periods must be protected against. Wear vibration reducing gloves and allow long breaks between uses. Protect against dust and swarf by wearing approved safety goggles or a face shield. These are some of the more common hazards and preventions; however, always find out what hazards are associated with the machine/work process and wear the most suitable protective equipment available.

**Do not breathe contaminated air.** If the work creates dust or fumes; connect the machine (if possible) to an extraction system either locally or remotely. Working outdoors can also help if possible.

**Move the machine as instructed.** If the machine is hand held, do not carry it by the power supply cable. If the product is heavy; employ a second or third person to help move it safely or use a mechanical device. Always refer to the instructions for the correct method.

**Do not overreach.** Extending your body too far can result in a loss of balance and you falling. This could be from a height or onto a machine and will result in injury.

**Maintain your tools correctly.** A well maintained tool will do the job safely. Replace any damaged or missing parts immediately with original parts from the manufacturer. As applicable; keep blades sharp; moving parts clean, oiled or greased; handles clean; and emergency devices working.

## 5. HEALTH AND SAFETY INFORMATION

---

**Wait for the machine to stop.** Unless the machine is fitted with a safety brake; some parts may continue to move due to momentum. Wait for all parts to stop; then unplug it from the power supply before making any adjustments, carrying out maintenance operations or just finishing using the tool.

**Remove and check setting tools.** Some machinery requires the use of additional tools or keys to set, load or adjust the power tool. Before starting the power tool always check to make certain they have been removed and are safely away from the machine.

**Prevent unintentional starting.** Before plugging any machine in to the power supply, make sure the switch is in the OFF position. If the machine is portable; do not hold the machine near the switch and take care when putting the machine down; that nothing can operate the switch.

**Carefully select an extension lead.** Some machines are not suitable for use with extension leads. If the tool is designed for use outdoors; use an extension lead also suitable for that environment. When using an extended lead, select one capable of handling the current (amps) drawn by the machine in use. Fully extend the lead regardless of the distance between the power supply and the tool. Excess current (amps) and a coiled extension lead will both cause the cable to heat up and can result in fire.

**Concentrate and stay alert.** Distractions are likely to cause an accident. Never operate a power tool if you are under the influence of drugs (prescription or otherwise), including alcohol or if you are feeling tired. Being disorientated will result in an accident.

**Have this tool repaired by a qualified person.** This tool is designed to conform to the relevant international and local standards and as such should be maintained and repaired by someone qualified; using only original parts supplied by the manufacturer: This will ensure the tool remains safe to use.

### 5.2 ADDITIONAL SAFETY INSTRUCTIONS FOR IMPACT DRIVERS

**Important:** Draper Tools Limited recommends that this machine should not be modified or used for any application other than that for which it was designed. If you are unsure of its relative applications do not hesitate to contact us in writing and we will advise you.

- Power tools shall not be used in potentially explosive atmospheres unless specifically designed for that purpose.
- Unexpected tool movement due to reaction forces or breakage of inserted tool or reaction bar may cause injuries.
- Power tools shall be isolated from the energy source before changing or adjusting the inserted tool.



#### **Warning!**

- There is a risk of loose clothing, hair etc., being caught in the rotating spindle of the power tool.

- Remove the battery pack from the impact driver before carrying out adjustments.
- Do not expose to rain or water.
- Avoid short circuit of the battery pack connections (screws & nails).

# 5. HEALTH AND SAFETY INFORMATION

---

## 5.3 RESIDUAL RISK

**Important:** Although the safety instructions and operating manuals for our tools contain extensive instructions of safe working with power tools, every power tool involves a certain residual risk which can not be completely excluded by safety mechanisms. Power tools must therefore always be operated with caution!

## 5.4 SAFETY INSTRUCTIONS FOR MAINS POWERED BATTERY PACKS AND CHARGERS (sold separately)

### Chargers

- The charger is for **indoor** use only.
- Prior to plugging the charger in to the supply, check that the plug and the cable are in good repair. If either are damaged, have the defective item replaced immediately by a suitably qualified person. If the casing of the battery charger is damaged, it is good policy to have the charger checked over by a suitably qualified person.
- Only use a correctly rated mains outlet to provide power, do not plug into site generators, attach to engine generators or D.C. sources. Do not use a mains socket outlet that is not switched.
- Use the correct Draper charger in conjunction with its corresponding battery pack (**see the table on page 11 for information**).
- Do not charge any other batteries with Draper chargers. Any other application is considered misuse.
- Do not attempt to charge battery packs that are too hot (over 30°C) or too cold (under 5°C); if these conditions apply set the battery aside to “normalise” before proceeding with the charging operation.
- Set up the charger and cable in a safe place where it won't be knocked, tripped over, stepped on, etc. and where it is well ventilated; make sure the ventilation slots in the charger case are not obstructed, plug the charger into the socket outlet.
- Inspect the battery pack for damage; if it is undamaged, plug it into the charger, ensuring the correct orientation. (Most chargers and batteries have ‘keys’ etc, to make sure the battery is not inserted incorrectly, if you are having to ‘force’ the battery into the charger, the chances are you have it the wrong way round, check and try again.)
- Switch the charger on and check that the correct indicators illuminate, allow the battery pack to charge (see the specific instructions for your charger). Once charging is complete, switch the charger off, remove the battery pack and store, repeat the procedure if you have more than one battery to charge.

**Caution:** When the battery charger has been continuously used, the battery charger will be hot. Once the charging has been completed, give 15 minutes rest until the next charge.

- If, when the charger was switched on, the correct indications did not occur, leave for two or three minutes to allow the charger to stabilise; if the correct indications occur, allow the charging cycle to proceed as normal. If no indication appears at all, switch off, remove the battery pack, unplug the charger, check that the charger contacts and the battery contacts are clean and repeat the process; if there is still no indication, switch off, remove the battery pack, unplug the charger and check the fuse. If the fuse is blown, replace and repeat the process; if the fuse blows again, or if the fuse was intact, attempt no further action. Refer the charger to a suitably qualified person for repair.



# 5. HEALTH AND SAFETY INFORMATION

---

## Battery packs

- Before charging, read the instructions.
- For **indoor** use. Do not expose to rain.
- Only use Draper battery packs with stock numbers **89437** and **89433** in conjunction with this product.
- Do not charge any other manufacturer's battery packs using Draper chargers. Any other application is considered misuse.
- The battery must be removed from the appliance before it is recycled.
- The charger must be disconnected from the supply mains when removing the battery.
- The battery is to be disposed of in-line with local Authority procedures.
- Do not use any other than the designated Draper batteries/chargers with this product.
- Do not crush, open or burn the battery. Exposure to potentially harmful materials may occur.
- In case of fire use CO2 or dry chemical extinguisher.
- Do not expose to high temperatures >50°C. The battery may degrade at high temperatures.
- Charge battery in conditions between 5°C to 30°C with the specified charger designed for this battery.
- Do not use battery if it has been stored at 5°C or less. Allow it to "normalise" at room temperature before usage/charging.



## Warning!

- Leaking battery packs
  - The electrolyte in battery packs is corrosive. Avoid contact with the skin.
  - If contact is made, flush the area with running water, pat dry and seek medical attention and advice at the earliest opportunity.
  - Inform medical personnel that the contaminant is a "high alkaline, corrosive liquid".
  - If electrolyte comes into contact with the eyes, flush with copious amounts of water only. Seek medical attention immediately, relaying the information above.

## 5.5 CONNECTION TO THE POWER SUPPLY (CHARGER (sold separately))

- Make sure the power supply information on the charger's rating plate is compatible with the power supply you intend to connect it to.
- The charger used by this product is designed for connection to a domestic power supply rated at 230V AC.
- If an extension lead is required, use an approved and compatible lead rated for this appliance. Follow the instructions supplied with the extension lead.
- If using an extension lead, follow the instructions that came with your lead regarding maximum load while the cable is wound. If in doubt, ensure that the entire cable is unwound. Using a coiled extension lead will generate heat, which could melt the lead and cause a fire.
- †Double insulated : The charger used by this product requires no earth connection as supplementary insulation is applied to the basic insulation to protect against electric shock in the event of failure of the basic insulation.

# 7. UNPACKING AND CHECKING

## 7.1 PACKAGING

Carefully remove the product from the packaging and examine it for any sign of damage that may have happened during shipping. Lay the contents out and check them against the parts shown below. If any part is damaged or missing; please contact the Draper Helpline (the telephone number appears on the Title page) and do not attempt to use the impact driver.

The packaging material should be retained at least during the guarantee period: in case the impact driver needs to be returned for repair.



### Warning!

- Some of the packaging materials used may be harmful to children. Do not leave any of these materials in the reach of children.
- If any of the packaging is to be thrown away, make sure they are disposed of correctly; according to local regulations.

## 7.2 20V POWER INTERCHANGE BATTERY PACKS/CHARGERS (sold separately)

This power product is supplied “naked”; without battery pack or charger.

The table below shows the Draper 20V Power Interchange compatible batteries and chargers available for this product.

20V Power Interchange tools all use universal 2.0 and 4.0Ah battery packs and chargers, enabling each battery to fit all tools within the range.



Item	Stock No.	Part No.	Voltage
Battery pack.	89437	B202LISF	20V/2.0Ah
Battery pack.	89433	B20LISF	20V/4.0Ah
Charger (for Stock No.89437).	89425	CB20	20V/2.4A
Charger (for Stock No.89433).	23793	CB203.5	20V/3.5A

# 6. TECHNICAL DESCRIPTION

## 6.1 IDENTIFICATION



- ① 1/4" Hex. (female) quick release collet.
- ② Variable speed trigger switch.
- ③ Hand grip.
- ④ LED Worklight.
- ⑤ 20V Li-ion battery pack (sold separately).
- ⑥ Belt clip.
- ⑦ Forward/reverse selector.

# 8. PREPARING THE IMPACT DRIVER

## 8.1 BATTERY PACK CHARGING – FIGS. 1 – 3

This power product is supplied “naked”; without battery pack or charger. Compatible batteries, chargers and accessories are available through Draper Tools stockists.

- Consult the table on page 11 of these instructions for a guide to the available battery packs and chargers compatible with this product.

**Important:** Only Draper designated battery packs and chargers can be used in conjunction with this product. Use of any other third party battery packs/chargers with this product is considered misuse and will invalidate the product’s warranty.

Once connected to the mains supply recharging of the battery pack can be left generally unsupervised requiring minimal attention. Complex circuit construction monitors the battery pack condition adjusting the recharge current to suit. When the recharge cycle is complete and to maintain the full capacity a low output current will continue as required.



### Warning!

- Check the condition of the charger and battery prior to each charge. If there is any sign of damage then do not commence charging, seek advice from Draper Tools.

To charge the battery pack (5), it must first be removed from the tool.

To release the battery pack:

- Press the battery pack release button (5.1) and gently slide the battery pack off (Fig.1).
- Plug the battery charger unit (8) into a 230V/AC 13amp, three pin socket.
- The green LED (8.1) will stay lit to show the charger has power.
- Slide the battery pack into place ensuring the battery terminals and the charger terminals make a good connection Fig.2.
- After a few seconds delay the red LED (8.2) will light to show the battery pack is being charged.



### Warning!

- Ensure battery pack is connected correctly. (Fig. 2). Sliding the battery pack on incorrectly may cause damage to the battery/charger.
  - When the battery pack is fully charged, the green LED (8.1) will light.



### Warning!

- If the indicator lights fail to illuminate during the charging cycle, unplug the charger from the power supply socket outlet and replace the battery pack.

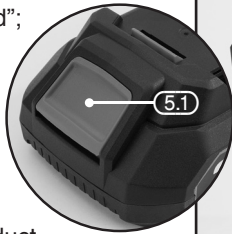
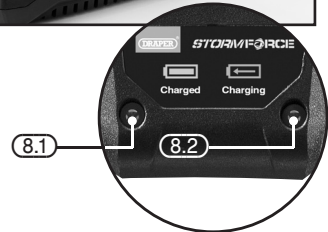

FIG.1



FIG.2



# 8. PREPARING THE IMPACT DRIVER

## Completing the charging cycle:

- Disconnect battery charger from the power supply.

**Caution:** Do not pull the plug out of the power supply by pulling on the cord.

- Make sure to grasp the plug when removing from power supply to avoid damaging the cord.

- Remove the battery pack from the battery charger.

- Supporting the battery charger with hand, pull out the battery pack from the battery charger

**Caution:** When the battery charger has been continuously used, the battery charger will be hot. Once the charging has been completed, give 15 minutes rest until the next charge.

If the battery pack is charged when it is warm due to battery use or exposure to sunlight, the battery pack will not be recharged. In such a case, let the battery pack cool before charge.

If the red indicator flickers rapidly at 0.2 - second intervals, check for and take out any foreign objects in the charger's battery slot. If there are no foreign objects, it is probable that the battery pack or charger is malfunctioning. Allow battery/charger to normalise and try again. If a fault remains after trying this then contact Draper Tools.

## 8.2 BATTERY PACK CHARGE STATUS

### – FIG.3

To display the amount of charge left in the battery pack press the charge level indicator button (5.2).

## 8.3 BATTERY PACK EFFICIENCY AND CHARGING ADVICE

- Recharge the battery packs before they become completely exhausted.
- When you feel that the power of the tool becomes weaker, stop using the tool and recharge the battery packs. If you continue to use the tool and exhaust the electric current, the battery pack may become damaged.
- Avoid recharging at high temperatures. A rechargeable battery pack will be hot immediately after use. If such a battery pack is recharged immediately after use, its internal chemical substance will deteriorate, and the battery life will be shortened. Leave the battery pack and recharge it after it has cooled for a while.
- The battery pack should only be used and/or charged when battery pack temperature is between 5°C and 30°C.
- The battery pack needs to be warmed-up or cooled down in order to prevent damage to the batteries internal components.

**Note:** Failure to warm up or cool down a battery pack could result in serious damage to the battery, charger and user.

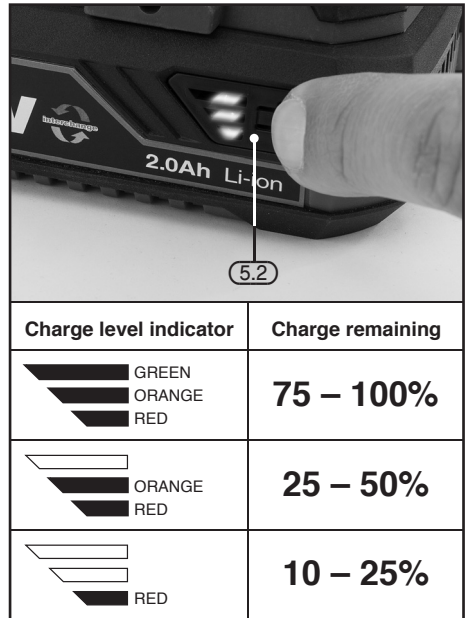
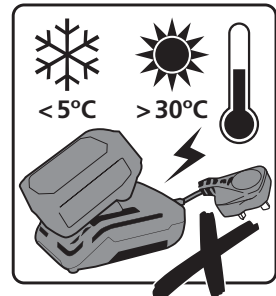

FIG.3



# 9. BASIC OPERATION



## 9.1 INSTALLING AND REMOVING BITS – FIG. 4

This driver is supplied with a ¼" Female Hex.

- Pull and hold the quick release collet ① outwards to insert and to release the bit.

**Note:** This product is equipped with an electric brake. Never use any bits or accessories that are not hardened for impact use.

## 9.2 ROTATIONAL DRIVE SELECTION – FIG.5

The forward/reverse drive selector switch ⑦ determines the direction of rotation of the drive, i.e. clockwise or anticlockwise.

To alter the direction of rotation:

- Stop the machine and push switch ⑦ to the left or right.
- When the direction switch is pushed to the left, the drive will rotate clockwise.
- When the switch is pushed to the right, the drive will rotate anticlockwise.
- Before operation, check that the switch is set in the required position. Do not change the direction of rotation until the driver comes to a complete stop.
- When the driver is not in use move the direction switch to the neutral position (the middle setting) to lock the trigger out.

**Note:** Failure to use the neutral position may activate the trigger inadvertently. This inadvertent operation may cause the driver to become damaged.

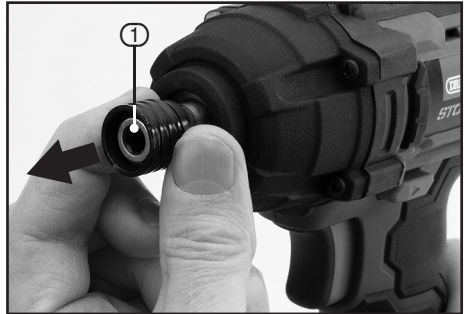

FIG.4

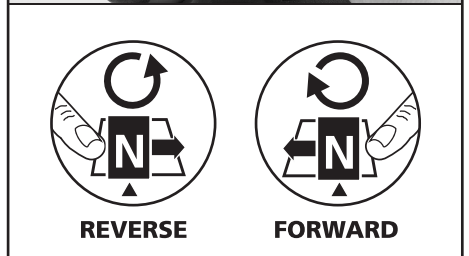

FIG.5

# 9. BASIC OPERATION



## 9.3 VARIABLE SPEED TRIGGER – FIG.6

When the trigger (2) is depressed, the drive will rotate (provided the direction switch (7) is set in the forward or reverse position). This trigger switch is electronic which enables the user to vary the speed continuously.

- The speed varies according to how far the trigger switch is depressed.
- The further it is depressed, the faster the drive spindle will rotate.
- The lighter it is depressed, the slower it will rotate.

**Note:** If the fastening is heavily corroded, or extremely tight, it may be necessary to release the fixing by hand before continuing with the driver.

**Note:** This product is equipped with an electric brake.

## 9.4 BELT CLIP – FIG.7

The spring steel belt clip (7) is convenient for hanging the drill temporarily. The clip can be installed on either side of the tool.

To install the clip:

- Locate the clip (6) in position and fasten with screw (6.1) supplied, take care to not overtighten and strip the thread.

## 9.5 LED WORKLIGHT – FIG.8

To aid use in confined, and inadequately lit spaces; the LED worklight (4) automatically illuminates when the trigger is activated.



FIG.6

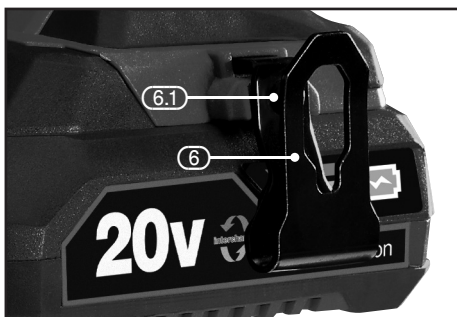

FIG.7

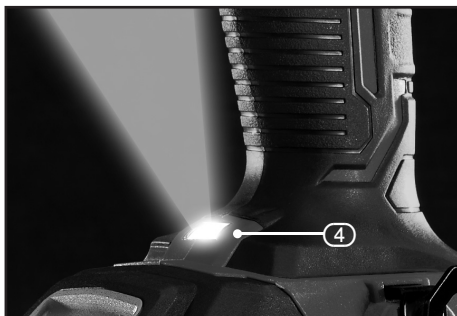

FIG.8

# 10. MAINTENANCE & TROUBLESHOOTING

---

## 10.1 MAINTENANCE

Regular inspection and cleaning reduces the necessity for maintenance operations and will keep your tool in good working condition.

The motor must be correctly ventilated during tool operation. Avoid blocking the air inlets and vacuum the ventilation slots regularly.

## 10.2 TROUBLESHOOTING GUIDE

**Note:** Remove the plug from the socket before carrying out adjustment, servicing or maintenance.

Problems	Possible cause	Required action
Motor does not start.	<ul style="list-style-type: none"><li>– Battery no charge.</li><li>– Battery faulty or damaged.</li></ul>	<ul style="list-style-type: none"><li>– Re-charge battery.</li><li>– Replace battery.</li></ul>
Motor runs, but slowly/ losing power.	<ul style="list-style-type: none"><li>– Battery no charge.</li><li>– Battery faulty or damaged.</li></ul>	<ul style="list-style-type: none"><li>– Re-charge battery.</li><li>– Replace battery.</li></ul>
Battery pack doesn't charge / non-illumination / non illumination of charger.	<ul style="list-style-type: none"><li>– Fuse blown in charger plug.</li><li>– Charger faulty.</li></ul>	<ul style="list-style-type: none"><li>– Replace fuse.</li><li>– Replace charger.</li></ul>



# 11. DISPOSAL

---



## 11.1 DISPOSAL

- At the end of the machine's working life, or when it can no longer be repaired, ensure that it is disposed of according to national regulations.
- Contact your local authority for details of collection schemes in your area.

In all circumstances:

- Do not dispose of power tools with domestic waste.
- Do not incinerate.
- Do not dispose of WEEE\* as unsorted municipal waste.



**Li-ion**

\* Waste Electrical & Electronic Equipment.

## 11.2 BATTERY PACK DISPOSAL INFORMATION



### Warning!

- Do not put battery pack in fire or mutilate – cells may burst or release toxic materials.
- Do not short circuit cells, may cause burns.
- The battery must be removed from the appliance before it is scrapped.
- The battery is to be disposed of safely.
- Do not mutilate batteries, corrosive electrolyte will be released.
- Do not dispose of batteries or cells in a charged condition.

Expired batteries must be recycled/disposed of in accordance with the appropriate regulation or legislation. They should be returned to your local warranty agent/stockist.

# 12. EXPLANATION OF SYMBOLS

## 12.1 EXPLANATION OF SYMBOLS



Read the instruction manual.



Wear safety glasses.



Wear ear defenders.



Wear protective gloves.



Long and loose hair must be contained or securely tied back.



Do not abandon into the environment.



Keep out of the reach of children.



**Warning!**



**Warning!** Risk of crushing.



Direction of rotation.



Single value noise marking.  
(Maximum declared A-Weighted sound power level in decibels).



Class II construction  
(Double insulated).



WEEE –  
Waste Electrical &  
Electronic Equipment.  
*Do not dispose of Waste Electrical & Electronic Equipment in with domestic rubbish.*



Lithium-ion product.

**Li-ion**



Do not incinerate or  
throw onto fire.



For indoor use only.  
Do not expose to rain.



Fuse.



Polarity indication.



Rated voltage.



## **CONTACTS**

Draper Tools Limited, Hursley Road,  
Chandler's Ford, Eastleigh, Hampshire. SO53 1YF. U.K.

Helpline: (023) 8049 4344

Sales Desk: (023) 8049 4333

Internet: [drapertools.com](http://drapertools.com)

E-mail: [sales@drapertools.com](mailto:sales@drapertools.com)

General Enquiries: (023) 8026 6355

**Service/Warranty Repair Agent:**

For aftersales servicing or warranty repairs, please contact the Draper Tools Helpline for details of an agent in your local area.

**YOUR DRAPER STOCKIST**

PJCH0218

©Published by Draper Tools Limited.

No part of this publication may be reproduced, stored in a retrieval system or transmitted in any form or by any means, electronic, mechanical photocopying, recording or otherwise without prior permission in writing from Draper Tools Ltd.