

**EN**

Original Instructions  
Version 2

**DRAPER**<sup>®</sup>

230V 15L WET & DRY

# VACUUM CLEANER

90107



UK  
CA CE

# 1. Preface

These are the original product instructions. This document is part of the product; retain it for the life of the product, passing it on to subsequent holders. Read this manual in full before attempting to assemble, operate or maintain this product.

This Draper Tools manual describes the purpose of the product and contains all the necessary information to ensure its correct and safe use. Following all the instructions and guidance in this manual will ensure the safety of both the product and the operator and increase the lifespan of the product.

All photographs and drawings within this manual are supplied by Draper Tools to help illustrate correct operation of the product.

Every effort has been made to ensure the information contained in this manual is accurate. However, Draper Tools reserves the right to amend this document without prior warning. Always use the latest version of the product manual.

## 1.1 Product Reference

**User Manual for:** 230V 15L Wet & Dry Vacuum Cleaner

**Stock No:** 90107

**Part No:** WDV15P

## 1.2 Revisions

**Version 1:** February 2019

First release

**Version 2:** August 2024

As our manuals are continually updated, always ensure that the latest version is used.

Please visit [drapertools.com/manuals](http://drapertools.com/manuals) for the latest version of this manual and the associated parts list, if applicable.

## 1.3 Understanding the Safety Content of This Manual



**WARNING!** – Situations or actions that may result in personal injury or death.



**CAUTION!** – Situations or actions that may result in damage to the product or surroundings.

**Important:** – Information or instructions of particular importance.

## 1.4 Copyright © Notice

Copyright © Draper Tools Limited.

Permission is granted to reproduce this manual for personal and educational use **ONLY**. Commercial copying, redistribution, hiring or lending is strictly prohibited.

No part of this manual may be stored in a retrieval system or transmitted in any other form or means without written permission from Draper Tools Limited.

In all cases, this copyright notice must remain intact.

---

1. Preface	2
1.1 Product Reference	2
1.2 Revisions	2
1.3 Understanding the Safety Content of This Manual	2
1.4 Copyright © Notice	2
2. Contents	3
3. Product Introduction	4
3.1 Intended Use	4
3.2 Specification	4
4. Health and Safety Information	5
4.1 General Health and Safety Precautions	5
4.2 Additional Health & Safety For Vacuum Cleaners	5
4.3 Connection to the Power Supply	5
4.4 Residual Risk	6
5. Identification and Unpacking	7
5.1 Product Overview	7
5.2 What's in the Box?	8
5.3 Packaging	8
6. Assembly Instructions	9
6.1 Fitting the Castors	9
7. Setting Up the Vacuum Cleaner	10
8. Operating Instructions	11
8.1 Dry Vacuuming	11
8.2 Wet Vacuuming	11
8.3 Blower Function	12
9. Maintenance and Troubleshooting	13
9.1 Troubleshooting	13
10. Spares, Returns and Disposal	14
11. Warranty	14
12. Explanation of Symbols	15

## 3. Product Introduction

---

### 3.1 Intended Use

This vacuum cleaner has a 15litre tank and is designed to pick up both wet and dry materials. Ideally suited for use in a workshop or garage and for DIY around the home.

Any other application beyond the conditions established for use will be considered misuse. Draper Tools accepts no responsibility for improper use of this product.

Read this manual in full before attempting to assemble, operate or maintain the product and retain it for later use.

### 3.2 Specification

Stock No.	90107
Part No.	WDV15P
Rated Voltage	230V/50Hz
Rated Input	1250W
Maximum Vacuum Pressure	15Kpa (150mbar)
Maximum Air Flow	25L/sec
Tank Capacity	15L
Liquid Volume	8L
Sound Pressure Level	86dB(A)
Protection Rating	IPX4
Power Cord Length (approx.)	5M
Net Weight (excluding accessories)	4.8kg

**Important:** Read all the Health and Safety instructions before attempting to operate, maintain or repair this product. Failure to follow these instructions may result in injury or damage to the user or the product.

### 4.1 General Health and Safety Precautions



#### **WARNING!**

To reduce the risk of electric shock or injury:

- **DO NOT** leave the appliance unattended when plugged in or switched on.
- **ALWAYS** switch off and unplug from the power supply when not in use, changing accessories or performing any cleaning or maintenance.
- **DO NOT** use this appliance near flammable liquids, gases or explosive vapours or dust. Sparks inside the motor can ignite flammable vapours or dust.
- **DANGER! DO NOT** vacuum hot or glowing ash, cigarette ends, matches or anything that is burning.
- Keep the cord away from hot surfaces and sharp edges.
- **DO NOT** expose to rain or very damp conditions.
- **DO NOT** pull or carry the appliance by the power cord.
- **DO NOT** pull the plug from the socket by the cord. To unplug grasp by the plug, not the cord.
- **DO NOT** use with a damaged or worn cord, plug or any other parts.
- If the appliance is not working, has been damaged, left outside or dropped in water, get it checked and repaired by a qualified person.
- **DO NOT** run the appliance over the cord.
- **DO NOT** touch the cord or appliance with wet hands.
- This appliance can be used by children aged from 8 years and above and persons with reduced physical, sensory or mental capabilities or lack of experience and knowledge if they have been given supervision or instruction concerning use of the appliance in a safe way and understand the hazards involved. Children shall not play with the appliance. Cleaning and user maintenance shall not be made by children without supervision.

### 4.2 Additional Health & Safety For Vacuum Cleaners

- **DO NOT** modify the appliance and only use for its intended use.
- Wear protective clothing and gloves.
- **DO NOT** allow untrained persons to operate the cleaner.
- To reduce the risk of health hazards from vapours and dust, **DO NOT** vacuum toxic materials.
- **DO NOT** use or store near hazardous materials.
- **DO NOT** use with a damaged filter or without a filter installed.
- **DO NOT** place any objects into the ventilation openings and **DO NOT** use if the ventilation openings are blocked.
- The hose should be checked regularly and must not be used if damaged.
- Unplug before connecting the hose.
- To reduce the risk of falls, take extra care when cleaning stairs.
- Keep hair, loose clothing and fingers away from openings and moving parts.
- Only use and replace with recommended parts and attachments.
- **When using as a blower:**
  - **DO NOT** point or direct the air hose at bystanders or animals.
  - Wear eye protection and a dust mask.
  - Keep children and bystanders away from the work area.

### 4.3 Connection to the Power Supply

This appliance is supplied with an approved plug and cord for your safety.

If the power supply cord is damaged, it must be replaced by Draper Tools, an authorised service agent or similarly qualified personnel in order to avoid a hazard.

The damaged or incomplete plug, when cut from the cord, shall be disabled to prevent connection to a live electrical outlet.

This appliance is a Class II† and is designed for connection to a power supply matching that detailed on the rating label and compatible with the plug fitted.

## 4. Health and Safety Information

---

The value of the fuse fitted is marked on the pin face of the plug. Should the fuse need replacing, use a small plain-slot screwdriver to remove the fuse cover.

Ensure the substitute is of the correct rating, approved to BS 1363/A and ASTA or BS Kite marked. This should only be performed by suitably qualified personnel.

ASTA 

BSI 

If an extension lead is required, use an approved and compatible lead rated for this appliance.

Follow all the instructions supplied with the extension lead.

**Important:** Always follow the extension lead instructions regarding maximum load while the cable is wound. It is recommended that the power cord and/or the extension lead are fully unwound before connecting to a power supply. A coiled extension lead generates heat which could melt the lead and cause a fire.

†Double insulated : This product is double insulated and does not require an earth connection to protect against electric shock from accessible conductive parts in the event of failure of the basic insulation.

It is recommended that this vacuum cleaner is used with a residual current device (RCD).

### 4.4 Residual Risk

The safety instructions in this manual cannot account for all possible conditions and situations that may occur. Exercise common sense and caution when using this product and protect against any additional conceivable risks.

## 5.1 Product Overview



- (1) ON/OFF switch
- (2) Carrying handle
- (3) Blower port (rear of vacuum)
- (4) Motor/pump housing

- (5) Retaining clips
- (6) Tank
- (7) Accessory holders
- (8) Vacuum port

## 5. Identification and Unpacking

### 5.2 What's in the Box?

Carefully remove the product from the packaging and examine it for any signs of damage that may have occurred during shipment.

Before assembling the product, lay the contents out and check them against the parts shown below. If any part is damaged or missing, do not attempt to use the product. Please contact the Draper Helpline; contact details can be found at the back of this manual.

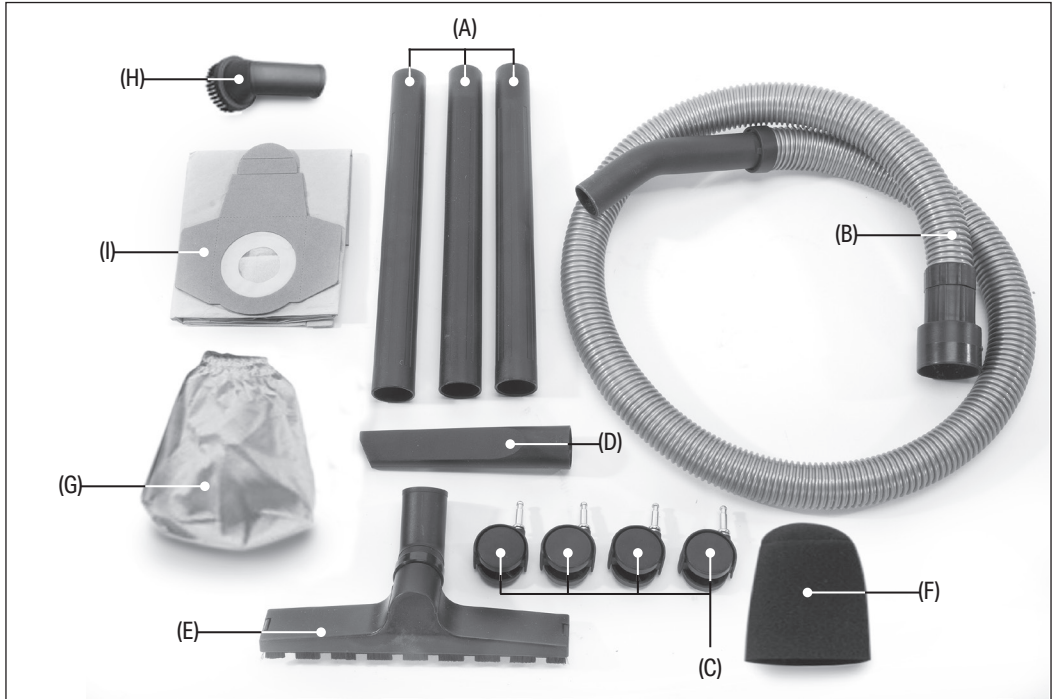

- (A) 3 x Extension tubes
- (B) Flexible suction hose
- (C) 4 x Castors
- (D) Crevice tool
- (E) Double function floor brush

- (F) Foam filter
- (G) Cloth filter
- (H) Round brush
- (I) Paper dustbag

### 5.3 Packaging

Keep the product packaging for the duration of the warranty period for reference should the product need to be returned for repair.

**WARNING! Keep packaging materials out of reach of children. Dispose of packaging correctly and responsibly and in accordance with local regulations.**

Please visit [drapertools.com](http://drapertools.com) for our full range of accessories and consumables.



**Important:** Before preparing or adjusting this product, read and understand all the safety instructions listed in this manual. Ensure that the vacuum cleaner is unplugged from the power supply before assembling.

**Note:** Remove all the accessories from inside the tank before fitting the castors and setting up the vacuum cleaner.

### 6.1 Fitting the Castors

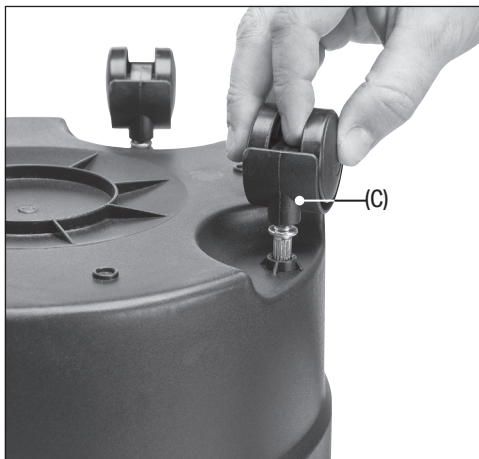

Fig. 1

- Firmly press the four castors (C) into the underside of the tank base. (Fig. 1).

## 7. Setting Up the Vacuum Cleaner

- Ensure the vacuum is unplugged from the power outlet before assembling.



Fig. 2

1. Release the retaining clips (5) and lift off the motor housing. (Fig. 2).
2. Fit the required and correct filter.
  - **Cloth filter (G)** and paper dustbag (I) for dry vacuuming (refer to **Section 8.1**).  
**NOT** suitable for wet vacuuming.
  - **Foam filter (F)** for wet vacuuming only (refer to **Section 8.2**).  
**NOT** suitable for dry vacuuming.
3. Refit the motor housing (4) and secure using the two retaining clips (5).
4. Push the flexible hose (B) into the port (8), align the notch with the arrow on the port housing. Then turn anticlockwise to lock in place. (Fig. 3).
  - To remove the hose, twist clockwise and pull out.

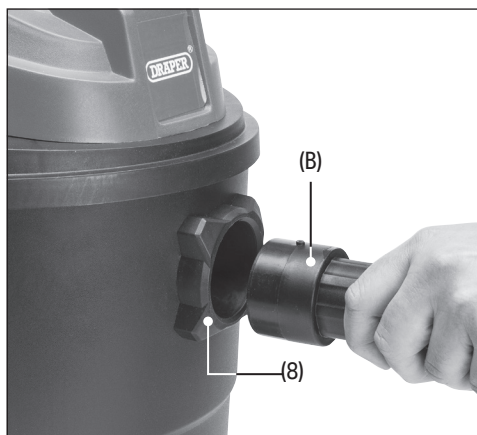

Fig. 3

5. Fit the required extension tubes (A) and attachment to the end of the hose.
  - Use the double function floor brush (E) on hard floors, parquet, cork, vinyl, ceramic etc.



Fig. 4

6. Connect to the power supply and push the '**ON/OFF**' switch to the '**I**' position. (Fig. 4).

**Important:** Before operating this product, read and understand all the safety instructions listed in this manual. Ensure that the product is fully assembled and correctly set up for use.

- **DO NOT operate the vacuum cleaner without the correct filter fitted.**
- Empty the tank before changing between wet and dry vacuuming.

## 8.1 Dry Vacuuming

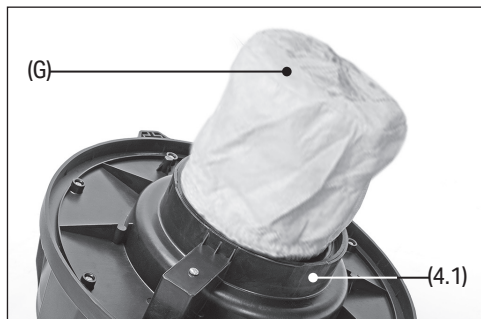

Fig. 5

1. Ensure the vacuum is unplugged from the power outlet.
2. Fit the cloth filter (G) over the filter cage (4.1). Ensure that it is pushed down securely and fully covers the filter/float cage. (Fig. 5).
  - **DO NOT** use the cloth filter for liquid vacuuming.



Fig. 6

- **Optional** – for improved filtration, fit a paper dust bag (I) as well as the cloth filter. As suction power decreases, replace the dustbag. (Fig. 6).

## 8.2 Wet Vacuuming

1. Ensure the vacuum is unplugged from the power outlet.
2. Remove the dustbag (I) and cloth filter (G) if fitted.

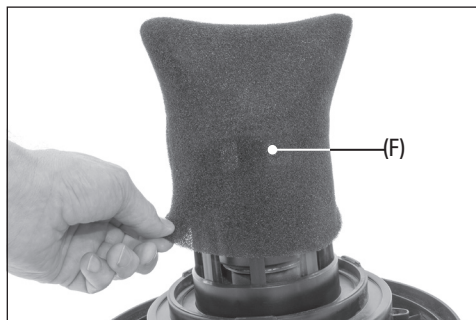

Fig. 7

3. Fit the foam filter (F) by carefully sliding the foam sleeve completely over the filter/float cage. (Fig. 7).

### Important:

- When vacuuming large quantities of liquids use the crevice tool (D), **DO NOT** immerse the tool nozzle completely in the liquid to allow for adequate air flow.

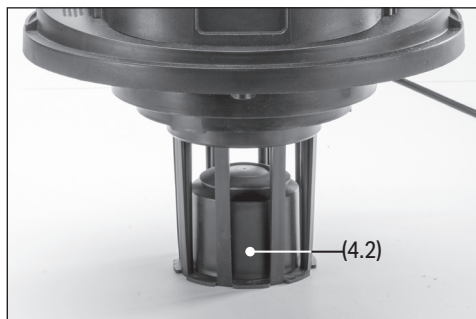

Fig. 8

- The vacuum is fitted with a float valve (4.2) that will cause the motor to work harder and become noisier when the maximum liquid level is reached. Empty the tank. (Fig. 8).

## 8. Operating Instructions

---

### 8.3 Blower Function

1. Ensure the vacuum cleaner is switched off and unplugged.
2. Check that the tank is empty before using the blower.

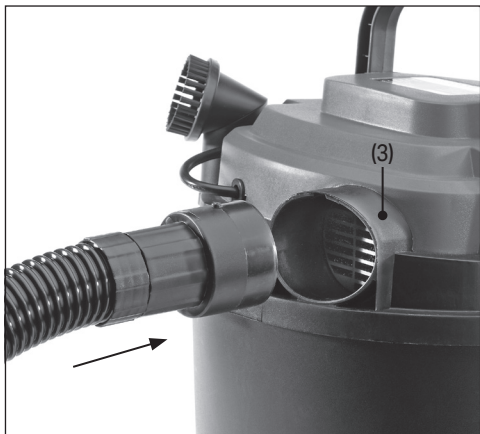

Fig. 9

3. Connect the flexible hose to the blower port (3), align the notch with the arrow on the port housing. Then turn anticlockwise to lock in place. (Fig. 9).
4. Connect to the power supply and push the '**ON/OFF**' switch to the 'I' position.

**Important:** All repairs and servicing should be carried out by a qualified person.

Always unplug from the power supply before carrying out any cleaning, adjustments, servicing or maintenance.

- Clean and maintain the vacuum cleaner correctly and regularly to ensure optimum performance.
- **Wet Vacuuming** – To prevent the risk of mildew, empty the tank and clean both inside and outside. Remove the foam filter and allow to dry before storage.
- Clean the cloth or foam filter with mild soap and water. Dry before refitting.

- **DO NOT** use abrasives or solvents to clean this product.
- The motor must be correctly ventilated during operation, so avoid blocking the air inlets.
- If the plug or power supply cord is damaged it must, for safety reason be replaced by Draper Tools, an authorised repairer or similarly qualified person in order to avoid a hazard.
- When not in use, store in a safe, dry and childproof location.

## 9.1 Troubleshooting

Problem	Possible Cause	Remedy
Vacuum not operating.	No power supply.	Check unit plugged in and power supply is working correctly.
	Faulty power cord.	Unplug and examine power cord. If damaged, contact the Draper Tools helpline for assistance.
	Switch not in the on 'I' position.	Move switch to 'I' position.
	Collection tank full.	Empty tank.
Dust coming from motor housing.	Cloth filter is missing or damaged.	Fit or replace cloth filter.
Reduced efficiency and motor noisy or vibrations noted.	Liquid at maximum level in tank.	Empty tank. Clean or replace foam filter.
	Blockage in tool, hose or tank collection inlet.	Unplug vacuum and check for blockage and clear.
	Cloth filter blocked by fine dust.	Clean or replace filter.

## 10. Spares, Returns and Disposal

---

For spare parts, servicing, and repair and replacement options, please contact the Draper Tools Product Helpline for details of your nearest authorised agent.

Draper Tools will endeavour to hold any spare parts, if applicable, for seven years from the date that it sells the final matching stock item.

Any servicing or repairs carried out by unauthorised personnel or installation of spare parts not supplied by Draper Tools will invalidate your warranty.

At the end of its working life, dispose of the product responsibly and in line with local regulations. Recycle where possible.

- **DO NOT** dispose of this product with domestic waste; most local authorities provide appropriate recycling facilities.



## 11. Warranty

---

Draper Tools products are carefully tested and inspected before shipment and are guaranteed to be free from defective materials and workmanship.

Should the tool develop a fault, return the complete tool to your nearest distributor or contact Draper Tools directly. Contact information can be found at the back of this manual.

Proof of purchase must be provided.

If, upon inspection, it is found that the fault occurring is due to defective materials or workmanship, repairs will be carried out free of charge. This warranty period covers parts and labour for 12 months from the date of purchase. Where tools have been hired out, the warranty period covers 90 days from the date of purchase.

This warranty does not apply to any consumable parts, batteries or normal wear and tear, nor does it cover any damage caused by misuse, careless or unsafe handling, alterations, accidents, or repairs attempted or made by any personnel other than the authorised Draper Tools repair agent.

In all cases, to make a claim for faulty workmanship or materials within the standard warranty period, please contact or return the product to the place of purchase. Proof of purchase may be required.

If the place of purchase is no longer trading or if you experience any difficulties with your warranty, please contact Customer Services with the product details and your proof of purchase. Contact details can be found at the back of this manual.

If the tool is not covered by the terms of this warranty, repairs and carriage charges will be quoted and charged accordingly.

This warranty supersedes any other guarantees expressed or implied and variations of its terms are not authorised.

Your Draper Tools guarantee is not effective until you can produce, upon request, a dated receipt or invoice to verify your purchase within the guarantee period.

Please note that this warranty is an additional benefit and does not affect your statutory rights.

**Draper Tools Limited**

## 12. Explanation of Symbols



Read the instruction manual



Wear face mask and safety glasses



For indoor use only;  
do not expose to rain



Class II construction  
(Double insulated)



WEEE –

Waste Electrical & Electronic Equipment

Do not dispose of Waste Electrical & Electronic Equipment  
in with domestic rubbish



European conformity



UK Conformity Assessed

## Contact Details

### **Draper Tools**

Draper Tools Limited  
Hursley Road  
Chandler's Ford  
Eastleigh  
Hampshire  
SO53 1YF  
UK

**Website:** [drapertools.com](http://drapertools.com)

**Email:** [sales@drapertools.com](mailto:sales@drapertools.com)

**Product Helpline:** +44 (0) 23 8049 4344

**Telephone Sales Desk:** +44 (0) 23 8049 4333

**General Enquiries:** +44 (0) 23 8026 6355

### **Delta International**

Delta International BV  
Oude Graaf 8  
6002 NL  
Weert  
Netherlands

Please contact the Draper Tools Product Helpline for repair and servicing enquiries.