

DRAPER[®]

230V 1/3 SHEET **SANDER**

92613



**UK
CA** **CE**

These instructions accompanying the product are the original instructions. This document is part of the product, keep it for the life of the product passing it on to any subsequent holder of the product. Read all these instructions before assembling, operating or maintaining this product.

This manual has been compiled by Draper Tools describing the purpose for which the product has been designed, and contains all the necessary information to ensure its correct and safe use. By following all the general safety instructions contained in this manual, it will ensure both product and operator safety, together with longer life of the product itself.

All photographs and drawings in this manual are supplied by Draper Tools to help illustrate the operation of the product.

Whilst every effort has been made to ensure the accuracy of information contained in this manual, the Draper Tools policy of continuous improvement determines the right to make modifications without prior warning.

1. INTRODUCTION

1.1 SCOPE

This machine is designed for the sanding of wood and similar materials only.

Part of our core range, this product is suitable for enthusiasts and tradespersons alike. Any application other than that it was intended for, is considered misuse.

This product is not a toy and must not be used by children or any person with reduced physical, sensory or mental capabilities or lack of experience and knowledge, or people unfamiliar with these instructions.

Local regulations may restrict the age of the operator.

1.2 UNDERSTANDING THIS MANUALS SAFETY CONTENT:

 **Warning!** – Information that draws attention to the risk of injury or death.

Caution! – Information that draws attention to the risk of damage to the product or surroundings.

1.3 EXPLANATION OF SYMBOLS



Read the instruction manual.



Wear face mask and suitable eye/face protection.



Wear ear defenders.



Wear protective gloves.



Long and loose hair must be contained or securely tied back.



Keep out of the reach of children.



Warning!



Machine weight.



Class II construction
(Double insulated).



WEEE –
Waste Electrical & Electronic Equipment.
Do not dispose of Waste Electrical & Electronic
Equipment in with domestic rubbish.



For indoor use only.
Do not expose to rain.



UK Conformity Assessed.



European conformity.

2. SPECIFICATION

2.1 SPECIFICATION

Stock No.....92613

Part No.1/3S-240D

Motor:

Rated voltage 230V~

Rated frequency50Hz

Rated input 240W

Orbits per minute (no load).....6000-12,000/min

Pad size..... 90x182mm

Sound pressure level (LpA):79.1dB(A)

Sound power level (LWA):..... 90.1dB(A)

Uncertainty (K):3dB(A)

Vibration level 7.050m/s²

Weight 2kg

3. HEALTH AND SAFETY INFORMATION

3.1 GENERAL SAFETY INSTRUCTIONS FOR POWER TOOL USE

 **Warning! Read all safety warnings, instructions, illustrations and specifications provided with this power tool.** Failure to follow all instructions listed below may result in electric shock, fire and/or serious injury.

Save all warnings and instructions for future reference.

The term “power tools” in the warnings refers to your mains-operated (corded) power tool or battery-operated (cordless) power tool.

1) Work area safety

- Keep work area clean and well lit.** Cluttered or dark areas invite accidents.
- Do not operate power tools in explosive atmospheres, such as in the presence of flammable liquids, gases or dust.** Power tools create sparks which may ignite the dust or fumes.

- c) **Keep children and bystanders away while operating a power tool.** Distractions can cause you to lose control.

2) Electrical safety

- a) **Power tool plugs must match the outlet. Never modify the plug in any way. Do not use any adapter plugs with earthed (grounded) power tools.** Unmodified plugs and matching outlets will reduce risk of electric shock.
- b) **Avoid body contact with earthed or grounded surfaces, such as pipes, radiators, ranges and refrigerators.** There is an increased risk of electric shock if your body is earthed or grounded.
- c) **Do not expose power tools to rain or wet conditions.** Water entering a power tool will increase the risk of electric shock.
- d) **Do not abuse the cord. Never use the cord for carrying, pulling or unplugging the power tool. Keep cord away from heat, oil, sharp edges or moving parts.** Damaged or entangled cords increase the risk of electric shock.
- e) **When operating a power tool outdoors, use an extension cord suitable for outdoor use.** Use of a cord suitable for outdoor use reduces the risk of electric shock.
- f) **If operating a power tool in a damp location is unavoidable, use a residual current device (RCD) protected supply.** Use of an RCD reduces the risk of electric shock.

3) Personal safety

- a) **Stay alert, watch what you are doing and use common sense when operating a power tool. Do not use a power tool while you are tired or under the influence of drugs, alcohol or medication.** A moment of inattention while operating power tools may result in serious personal injury.
- b) **Use personal protective equipment Always wear eye protection.** Protective equipment such as a dust mask, non-skid safety shoes, hard hat or hearing protection use for appropriate conditions will reduce personal injuries.
- c) **Prevent unintentional starting. Ensure the switch is in the off-position before connecting to power source and/or battery pack, picking up or carrying the tool.** Carrying power tools with your finger on the switch or energising power tools that have the switch on invites accidents.
- d) **Remove any adjusting key or wrench before turning the power tool on.** A wrench or a key left attached to a rotating part of the power tool may result in personal injury.
- e) **Do not overreach. Keep proper footing and balance at all times.** This enables better control of the power tool in unexpected situations.

- f) **Dress properly. Do not wear loose clothing or jewellery. Keep your hair and clothing away from moving parts.** Loose clothes, jewellery or long hair can be caught in moving parts.

- g) **If devices are provided for the connection of dust extraction and collection facilities, ensure these are connected and properly used.** Use of dust collection can reduce dust-related hazards.
- h) **Do not let familiarity gained from frequent use of tools allow you to become complacent and ignore tool safety principles.** A careless action can cause severe injury within a fraction of a second.

4) Power tool use and care

- a) **Do not force the power tool. Use the correct power tool for your application.** The correct power tool will do the job better and safer at the rate for which it was designed.
- b) **Do not use the power tool if the switch does not turn it on and off.** Any power tool that cannot be controlled with the switch is dangerous and must be repaired.
- c) **Disconnect the plug from the power source and/or remove the battery pack, if detachable, from the power tool before making any adjustments, changing accessories, or storing power tools.** Such preventive safety measures reduce the risk of starting the power tool accidentally.
- d) **Store idle power tools out of the reach of children and do not allow persons unfamiliar with the power tool or these instructions to operate the power tool.** Power tools are dangerous in the hands of untrained users.
- e) **Maintain power tools and accessories. Check for misalignment or binding of moving parts, breakage of parts and any other condition that may affect the power tool's operation. If damaged, have the power tool repaired before use.** Many accidents are caused by poorly maintained power tools.
- f) **Keep cutting tools sharp and clean.** Properly maintained cutting tools with sharp cutting edges are less likely to bind and are easier to control.
- g) **Use the power tool, accessories and tool bits etc. in accordance with these instructions, taking into account the working conditions and the work to be performed.** Use of the power tool for operations different from those intended could result in a hazardous situation.
- h) **Keep handles and grasping surfaces dry, clean and free from oil and grease.** Slippery handles and grasping surfaces do not allow for safe handling and control of the tool in unexpected situations.

5) Service

- a) **Have your power tool serviced by a qualified repair person using only identical replacements parts.** This will ensure that the safety of the power tool is maintained.

3.2 ADDITIONAL SAFETY INSTRUCTIONS FOR BELT AND DRUM SANDERS

Warning!

1) Safety instructions for all operations

- a) **Hold the power tool by insulated gripping surfaces, because the sanding surface may contact its own cord.** Cutting a “live” wire may make exposed metal parts of the power tool “live” and could give the operator an electric shock.

3.3 RESIDUAL RISK

Important: Although the safety instructions and operating manuals for our tools contain extensive instructions of safe working with power tools, every power tool involves a certain residual risk which can not be completely excluded by safety mechanisms. Power tools must therefore always be operated with caution!

3.4 CONNECTION TO THE POWER SUPPLY

Caution: Risk of electric shock. Do not open.

This appliance is supplied with an approved plug and cable for your safety.

Never use a damaged or incomplete plug.

This appliance is Class II[†] and is designed for connection to a power supply matching that detailed on the rating label and compatible with the plug fitted.

Carefully select an extension lead. Some machines are not suitable for use with extension leads. If the tool is designed for use outdoors, only use an extension lead suitable for that environment in conjunction with an RCD adaptor. When using an extension lead, select one capable of handling the current (amps) drawn by the machine in use. Ensure the cable is fully unwound regardless of the distance between the power supply and the tool. Excess current (amps) and a coiled extension lead will cause the cable to heat up and can result in fire.

Keep extension leads away from moving hazardous parts to avoid damages to the cable which can lead to contact with live parts. Position cable safely to avoid tripping over.

[†]Double insulated : This product requires no earth connection as supplementary insulation is applied to the basic insulation to protect against electric shock in the event of failure of the basic insulation.

Important! If using an extension lead, follow the instructions that came with your lead regarding maximum load while cable is wound. If in doubt, ensure

that the entire cable is unwound. Using a coiled extension lead will generate heat which could melt the lead and cause a fire.

4. UNPACKING AND CHECKING

4.1 PACKAGING

Carefully remove the product from the packaging and examine it for any sign of damage. Check contents against the parts shown in Fig A. If any part is damaged or missing, please contact the Draper Help Line (see back page). Do not attempt to use the product!

The packaging material should be retained during the warranty period, in case the product needs to be returned for repair.

Warning!

- Some of the packaging materials may be harmful to children. Do not leave any of these materials in reach of children.
- If any of the packaging is to be thrown away, make sure it is disposed of correctly, according to local regulations.

5. IDENTIFICATION – FIG.A

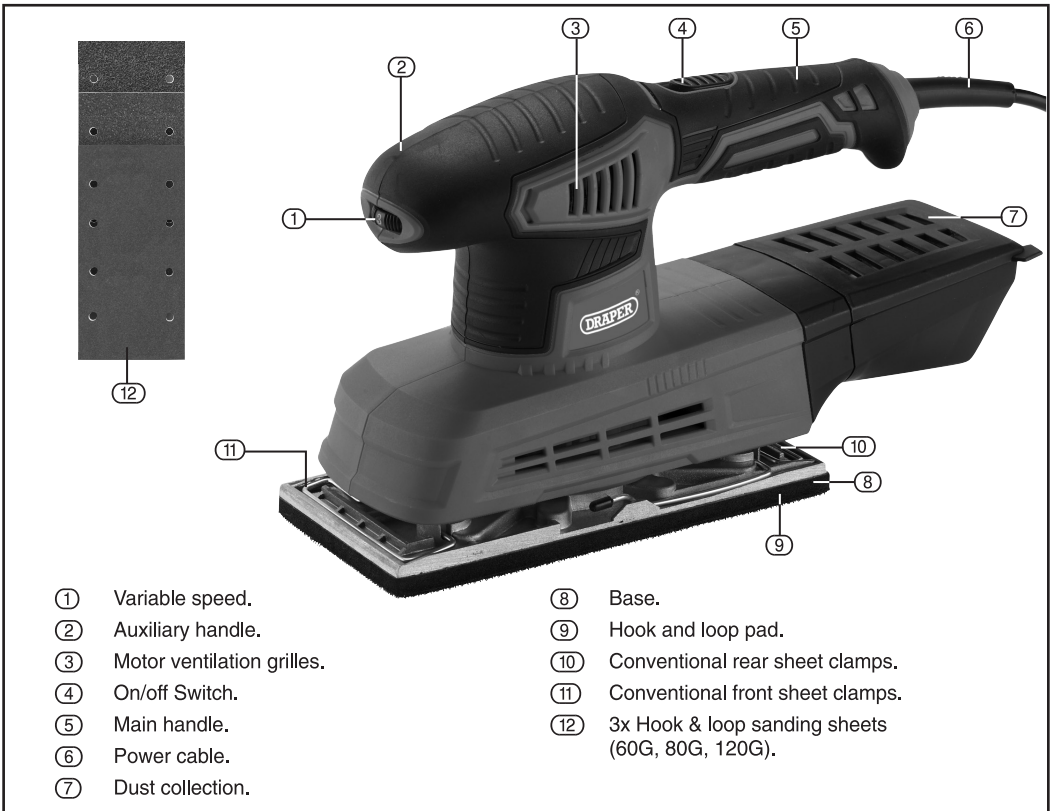

FIG.A

Note: For details of our full range of accessories and consumables, please visit drapertools.com

6. BASIC SANDER OPERATIONS

Note: Remove the plug from the socket before carrying out adjustment, servicing or maintenance.

6.1 SWITCHING ON/OFF – FIG. 1

Ensure the sander is raised off the workpiece.
 To start the sander place the switch (④) to the “I” position. To stop the sander place the switch into the “O” position.

This machine is intended for light/medium-duty sanding of wood and similar materials only.

Apply equal pressure on the workpiece with the base pad remaining flat. Attempting to sand areas using only the edge will damage the base pad.

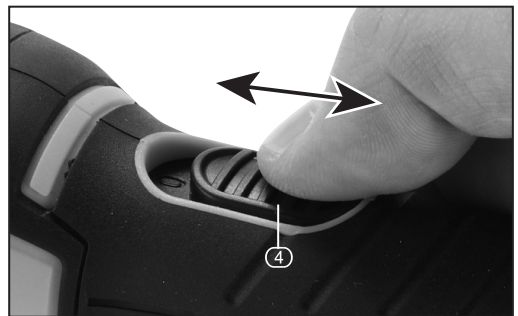

FIG. 1

Note: Excess pressure when sanding reduces the effectiveness of tool and will overload the motor.

Abrasive sheets are consumable items. Replace abrasive sheets when clogged with material or when surface/edge has rips, cracks or worn areas.

6.2 ABRASIVE SHEET INSTALLATION/ REPLACEMENT – FIG. 2

The sanding sheets are simply pressed onto the base pad. The holes in the sander must align with the holes in the sanding sheet for maximum dust extraction.

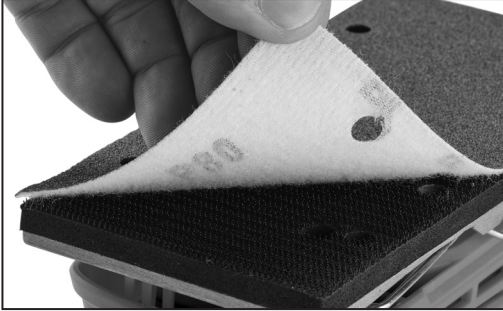

FIG. 2

6.3 CONVENTIONAL ABRASIVE SHEET INSTALLATION / REPLACEMENT - FIG. 3

- In order to fix the abrasive paper, proceed as follows:
- Open one fixing clamp (10) and insert one end of the abrasive paper into the exact position. Close clamp.
- Position the sheet of abrasive paper on the base pad and wrap the sheet around the front of the base pad (9).
- Open the second clamp (11) and insert the other end of the abrasive paper then close clamp. Check that the sheet is firmly secured and that it completely covers the base pad of the tool. Abrasive sheet must be centrally positioned and taught over the base pad.

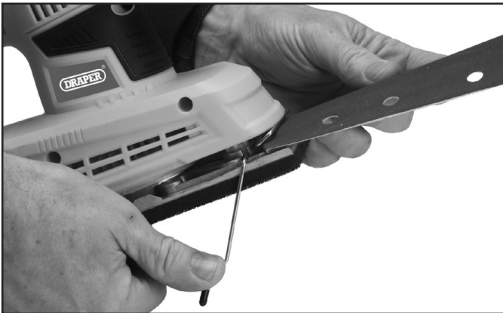

FIG. 3

6.4 ABRASIVE PAPER

Only use good quality abrasive paper as this will improve the sanding efficiency and reduce working time. Use coarse grade (60, or 80) sanding sheets when large quantities of material need to be removed. For finishing work use 120 grade sanding sheets.

Note: Abrasive sheets and the sander base pad are consumable items.

Note: Remove the plug from the socket before carrying out adjustment, servicing or maintenance.

6.5 DUST – FIGS. 4 - 5

Inhalation of dust particles can be detrimental to health. The dust outlet (7.1) can be connected to a dust extraction machine.

The dust extraction box (7) can be used instead when connection to a dust extractor is not practical to reduce amount of air borne dust.

The dust box is attached by simply pushing it onto the outlet port until the sides of the box meet the body of the sander.

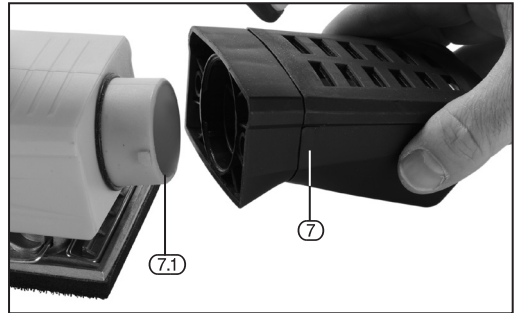

FIG. 4

Removing and emptying the dust collection box

- Disconnect the plug from the electricity supply.
- Hold your sander vertically with the dust collector at the bottom, pull the box gently down.
- Remove the top of the dust collection box and empty.



FIG. 5

A click is heard when the dust box is correctly fitted.

Do not wash the dust box/filter.

Empty the dust collection box/filter at regular intervals.

Warning! All wood dust (including dust from composites like chipboards and fibre boards, etc.) is hazardous to health. It can affect the nose, the

respiratory system and the skin. For example: medium density fibreboard contains formaldehyde which is a known carcinogen. In addition to the above measures, a correctly fitted dust mask, suitable for the activity and in accordance to the relevant standard, must be worn.

7. MAINTENANCE

7.1 MAINTENANCE

Regular inspection and cleaning reduces the necessity for maintenance and will keep your tool in good working condition.

The sander must be correctly ventilated during tool operation. Avoid blocking the air inlets and vacuum the ventilation slots regularly.

Do not use solvents or fuels to clean the product. When not in use, store the product in a safe, dry place.

8. WARRANTY

8.1 WARRANTY

Draper tools have been carefully tested and inspected before shipment and are guaranteed to be free from defective materials and workmanship.

Should the tool develop a fault, please return the complete tool to your nearest distributor or contact:
Draper Tools Limited

UK: Chandler's Ford, Eastleigh, Hampshire,
SO53 1YF. England.

EU: Oude Graff 8, 6002 NL Weert (NL).

Telephone Sales Desk: +44 (0)23 8049 4333 or:

Product Helpline +44 (0)23 8049 4344.

A proof of purchase must be provided.

If upon inspection it is found that the fault occurring is due to defective materials or workmanship, repairs will be carried out free of charge. This warranty period covering parts/labour is 24 months from the date of purchase except where tools are hired out when the warranty period is 90 days from the date of purchase. This warranty does not apply to any consumable parts, any type of battery or normal wear and tear, nor does it cover any damage caused by misuse, careless or unsafe handling, alterations, accidents, or repairs attempted or made by any personnel other than the authorised Draper warranty repair agent.

Note: If the tool is found not to be within the terms of warranty, repairs and carriage charges will be quoted and made accordingly.

This warranty applies in lieu of any other warranty expressed or implied and variations of its terms are not authorised.

Your Draper warranty is not effective unless you can produce upon request a dated receipt or invoice to verify your proof of purchase within the warranty period.

Please note that this warranty is an additional benefit

and does not affect your statutory rights.

Draper Tools Limited.

9. DISPOSAL

9.1 DISPOSAL

- At the end of the machine's working life, or when it can no longer be repaired, ensure that it is disposed of according to national regulations.
- Contact your local authority for details of collection schemes in your area.

In all circumstances:

- Do not dispose of power tools with domestic waste.
- Do not incinerate.
- Do not dispose of WEEE* as unsorted municipal waste.



* *Waste Electrical & Electronic Equipment.*