

**DRAPER**<sup>®</sup>

**D20**  
MULTI-TOOL BATTERY SYSTEM

GB

20V 2-IN-1

# GRASS & HEDGE TRIMMER

98505 & 94594



These instructions accompanying the product are the original instructions. This document is part of the product, keep it for the life of the product passing it on to any subsequent holder of the product. Read all these instructions before assembling, operating or maintaining this product.

This manual has been compiled by Draper Tools describing the purpose for which the product has been designed, and contains all the necessary information to ensure its correct and safe use. By following all the general safety instructions contained in this manual, it will ensure both product and operator safety, together with longer life of the product itself.

All photographs and drawings in this manual are supplied by Draper Tools to help illustrate the operation of the product.

Whilst every effort has been made to ensure the accuracy of information contained in this manual, the Draper Tools policy of continuous improvement determines the right to make modifications without prior warning.

# 1. TITLE PAGE

---

## 1.1 INTRODUCTION:

**USER MANUAL FOR: 20V 2-in-1 Grass & Hedge Trimmer**

**Stock No: 98505**

**Part No: D20G/GST20**

## 1.2 REVISIONS:

---

**Date first published September 2020**

---

**First revision June 2022**

---

**Second revision October 2023**

---

---

As our user manuals are continually updated, users should make sure that they use the very latest version.

**Downloads are available from:** <http://drapertools.com/manuals>

Draper Tools Limited  
Hursley Road  
Chandler's Ford  
Eastleigh  
Hampshire  
SO53 1YF  
UK

Delta International  
Delta International BV  
Oude Graaf 8  
6002 NL  
Weert  
Netherlands

**Website:** [drapertools.com](http://drapertools.com)

**Product Help Line:** +44 (0) 23 8049 4344

**General Fax:** +44 (0) 23 8026 0784

## 1.3 UNDERSTANDING THIS MANUALS SAFETY CONTENT:

**Warning!** – Information that draws attention to the risk of injury or death.

**Important** – Information that draws attention to the risk of damage to the product or surroundings.

## 1.4 COPYRIGHT © NOTICE:

Copyright © Draper Tools Limited.

Permission is granted to reproduce this publication for personal and educational use only.

Commercial copying, redistribution, hiring or lending is prohibited.

No part of this publication may be stored in a retrieval system or transmitted in any other form or means without written permission from Draper Tools Limited.

In all cases this copyright notice must remain intact.

# 2. CONTENTS

---

## 2.1 TABLE OF CONTENTS

### 1. TITLE PAGE

1.1	INTRODUCTION:.....	2
1.2	REVISIONS:.....	2
1.3	UNDERSTANDING THIS MANUALS SAFETY CONTENT:.....	2
1.4	COPYRIGHT © NOTICE:.....	2

### 2. CONTENTS

2.1	TABLE OF CONTENTS .....	3
-----	-------------------------	---

### 3. WARRANTY

3.1	WARRANTY.....	4
-----	---------------	---

### 4. INTRODUCTION

4.1	SCOPE.....	5
4.2	SPECIFICATION.....	5
4.3	HANDLING AND STORAGE.....	5

### 5. HEALTH AND SAFETY INFORMATION

5.1	GENERAL SAFETY INSTRUCTIONS FOR POWER TOOL USE.....	6
5.2	SPECIFIC SAFETY INSTRUCTIONS FOR CORDLESS GRASS/HEDGE TRIMMERS.....	7
5.3	RESIDUAL RISK.....	7

### 6. TECHNICAL DESCRIPTION

6.1	IDENTIFICATION.....	8
-----	---------------------	---

### 7. UNPACKING AND CHECKING

7.1	PACKAGING .....	9
7.2	D20 MULTI-TOOL INTERCHANGEABLE BATTERY SYSTEM.....	9

### 8. PREPARING THE GRASS & HEDGE TRIMMER

8.2	BATTERY PACK PROTECTION FEATURES.....	11
8.3	BATTERY PACK CHARGE STATUS .....	11
8.4	BATTERY LIFE EFFICIENCY AND CHARGING ADVICE.....	11

### 9. OPERATION

9.1	SWITCHING ON & OFF.....	13
-----	-------------------------	----

### 10. MAINTENANCE AND TROUBLESHOOTING

10.1	GENERAL MAINTENANCE .....	14
10.2	CLEANING & STORAGE.....	14

### 11. DISPOSAL

11.1	DISPOSAL .....	14
------	----------------	----

### 12. EXPLANATION OF SYMBOLS

12.1	EXPLANATION OF SYMBOLS.....	15
------	-----------------------------	----

## 3. WARRANTY

---

### 3.1 WARRANTY

Draper power tools have been carefully tested & inspected and are guaranteed to be free from defective materials or workmanship.

For details of warranty and terms and conditions please visit the Draper Tools website at [www.drapertools.com/warranty](http://www.drapertools.com/warranty)

## 4. INTRODUCTION

---

### 4.1 SCOPE

This manual is intended to give the user an overview of the function and controls of this product to aid its safe and effective use. Any application other than that it was intended for, is considered misuse.

### 4.2 SPECIFICATION

Stock No.....	98505
Part No. ....	D20G/GST20
Cutting width:	
Grass shear.....	80mm
Hedge trimmer.....	210mm
Hedge trimmer cutting thickness: .....	8mm
Sound pressure level (LpA): .....	83dB(A)
Sound power level (LWA): .....	90dB(A)
Uncertainty (K): .....	3dB(A)
Vibration level: .....	2.0m/s <sup>2</sup>
Uncertainty (K) .....	1.5m/s <sup>2</sup>
Maximum running time (no load).....	90 minutes (approx.)
Weight:	
Bare machine .....	0.81kg
Maximum weight (with hedge cutting attachment and battery) .....	2kg

### 4.3 HANDLING AND STORAGE

- Care must be taken when handling this product.
  - Dropping this power tool could have an effect on its accuracy and could also result in personal injury. This product is not a toy and must be respected.
- Environmental conditions can have a detrimental effect on this product if neglected.
  - Exposure to damp air can gradually corrode components. If the product is unprotected from dust and debris, components will become clogged.
  - If not cleaned and maintained correctly or regularly, the machine will not perform at its best.

## 5. HEALTH AND SAFETY INFORMATION

---

### 5.1 GENERAL SAFETY INSTRUCTIONS FOR POWER TOOL USE

When using any type of power tool there are steps that should be taken to make sure that you, as the user, remain safe.

Common sense and a respect for the tool will help reduce the risk of injury.

**Read the instruction manual fully.** Do not attempt any operation until you have read and understood this manual.

Most important you must know how to safely start and stop this machine, especially in an emergency.

**Keep the work area tidy and clean.** Attempting to clear clutter from around the machine during use will reduce your concentration. Mess on the floor creates a trip hazard. Any liquid spilt on the floor could result in you slipping.

**Find a suitable location.** If the machine is bench mounted, the location should provide good natural light or artificial lighting as a replacement. Avoid damp and dust locations as it will have a negative effect on the machine's performance. If the machine is portable do not expose the tool to rain. In all cases do not operate power tools near any flammable materials.

**Keep bystanders away.** Children, onlookers and passers by must be restricted from entering the work area for their own protection. The barrier must extend a suitable distance from the tool user.

Unplug and house all power tools that are not in use. A power tool should never be left unattended while connected to the power supply. They must be housed in a suitable location, away locked up and from children. This includes battery chargers.

**Do not overload or misuse the tool.** All tools are designed for a purpose and are limited to what they are capable of doing. Do not attempt to use a power tool (or adapt it in any way) for an application it is not designed for. Select a tool appropriate for the size of the job. Overloading a tool will result in tool failure and user injury. This covers the use of accessories.

**Dress properly.** Loose clothing, long hair and jewellery are all dangerous because they can become entangled in moving machinery. This can also result in parts of body being pulled into the machine. Clothing should be close fitted, with any long hair tied back and jewellery and neck ties removed. Footwear must be fully enclosed and have a non-slip sole.

**Wear personal protective equipment (PPE).** Dust, noise, vibration and swarf can all be dangerous if not suitably protected against. If the work involving the power tool creates dust or fumes wear a dust mask. Vibration to the hand, caused by operating some tools for longer periods must be protected against. Wear vibration reducing gloves and allow long breaks between uses. Protect against dust and swarf by wearing approved safety goggles or a face shield. These are some of the more common hazards and preventions, however, always find out what hazards are associated with the machine/work process and wear the most suitable protective equipment available.

**Do not breathe contaminated air.** If the work creates dust or fumes connect the machine (if possible) to an extraction system either locally or remotely. Working outdoors can also help if possible.

**Move the machine as instructed.** If the machine is hand held, do not carry it by the power supply cable. If the product is heavy, employ a second or third person to help move it safely or use a mechanical device. Always refer to the instructions for the correct method.

**Do not overreach.** Extending your body too far can result in a loss of balance and you falling. This could be from a height or onto a machine and will result in injury.

**Maintain your tools correctly.** A well maintained tool will do the job safely. Replace any damaged or missing parts immediately with original parts from the manufacturer. As applicable, keep blades sharp, moving parts clean, oiled or greased, handles clean, and emergency devices working.

**Wait for the machine to stop.** Unless the machine is fitted with a safety brake, some parts may continue to move due to momentum. Wait for all parts to stop, then unplug it from the power supply

## 5. HEALTH AND SAFETY INFORMATION

---

before making any adjustments, carrying out maintenance operations or just finishing using the tool.

**Remove and check setting tools.** Some machinery requires the use of additional tools or keys to set, load or adjust the power tool. Before starting the power tool always check to make certain they have been removed and are safely away from the machine.

**Prevent unintentional starting.** Before plugging any machine in to the power supply, make sure the switch is in the OFF position. If the machine is portable, do not hold the machine near the switch and take care when putting the machine down, that nothing can operate the switch.

**Carefully select an extension lead.** Some machines are not suitable for use with extension leads. If the tool is designed for use outdoors, use an extension lead also suitable for that environment. When using an extended lead, select one capable of handling the current (amps) drawn by the machine in use. Fully extend the lead regardless of the distance between the power supply and the tool. Excess current (amps) and a coiled extension lead will both cause the cable to heat up and can result in fire.

**Concentrate and stay alert.** Distractions are likely to cause an accident. Never operate a power tool if you are under the influence of drugs (prescription or otherwise), including alcohol or if you are feeling tired. Being disorientated will result in an accident.

**Have this tool repaired by a qualified person.** This tool is designed to conform to the relevant international and local standards and as such should be maintained and repaired by someone qualified, using only original parts supplied by the manufacturer. This will ensure the tool remains safe to use.

### 5.2 SPECIFIC SAFETY INSTRUCTIONS FOR CORDLESS GRASS/HEDGE TRIMMERS

**Warning!** For your safety, please read and understand these instructions before assembling, operating or maintaining this machine.

- Never attempt to modify or operate a modified machine.
- Do not operate this machine without being completely familiar with the safety features and how to operate them.
- Never operate this machine if the stop switch is faulty or not functioning.
- Never operate this machine while tired, ill or under the influence of drugs.

**Warning!** Keep out of the reach of children.

- Never allow people unfamiliar with these instructions to operate this machine.
- Prior to each use, inspect the machine for signs of damage.

**Warning!** Use of this product can pose a danger to wildlife. Before attempting to use this machine, check the area, particularly long grass and under bushes for signs of life – if necessary relocate.

**Note:** Not all animals will be deterred by the noise of the product alone.

**Caution.** As the user you are responsible for any injury to people or damage to property.

- Always be aware of your surroundings, staying alert for possible hazards that you may not hear over the noise of the motor.
- Always wear appropriate PPE [Personal Protective Equipment].

### 5.3 RESIDUAL RISK

**Important:** Although the safety instructions and operating manuals for our tools contain extensive instructions of safe working with power tools, every power tool involves a certain residual risk which can not be completely excluded by safety mechanisms. Power tools must therefore always be operated with caution!

## 6. TECHNICAL DESCRIPTION

### 6.1 IDENTIFICATION

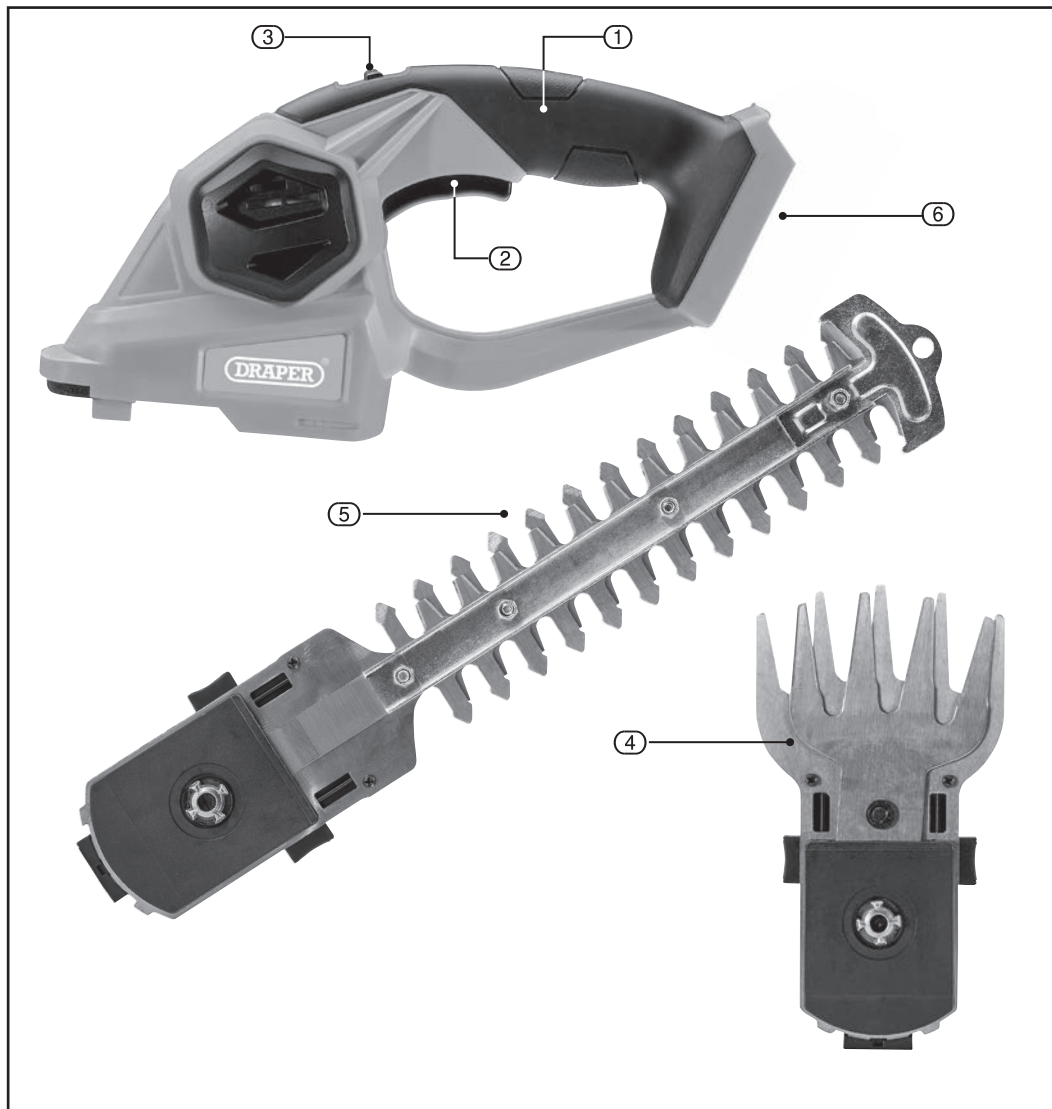

- ① Handle grip.
- ② ON/OFF trigger
- ③ Safety lock-off button.
- ④ Grass shear attachment.
- ⑤ Hedge cutting attachment.
- ⑥ Battery compartment.



## 7. UNPACKING AND CHECKING

---

### 7.1 PACKAGING

Carefully remove the product from the packaging and examine it for any sign of damage that may have happened during shipping. Lay the contents out and check them against the parts shown below. If any part is damaged or missing, please contact the Draper Help Line (the telephone number appears on the Title page) and do not attempt to use the product.

The packaging material should be retained at least during the warranty period, in case the machine needs to be returned for repair.

#### **Warning!**

- Some of the packaging materials used may be harmful to children. Do not leave any of these materials in the reach of children.
- If any of the packaging is to be thrown away, make sure they are disposed of correctly, according to local regulations.

### 7.2 D20 MULTI-TOOL INTERCHANGEABLE BATTERY SYSTEM

The D20 range of tools are a range of tools suitable for enthusiasts and tradespersons alike, featuring a wide array of machines all running from the same range of batteries. Many different capacity batteries are available making sure you can balance tool weight with longevity and find a battery that meets your needs.

For details of our full range of accessories and consumables, please visit [drapertools.com](http://drapertools.com)



## 8. PREPARING THE GRASS & HEDGE TRIMMER

### 8.1 BATTERY PACK CHARGING –

#### FIGS. 1 – 3

This power product is supplied “bare”, without battery pack or charger. For compatible batteries, chargers and accessories please visit [www.drapertools.com](http://www.drapertools.com).

**Important:** Only Draper D20 designated battery packs and chargers can be used in conjunction with this product. Use of any other third party battery packs/chargers with this product is considered misuse and will invalidate the product’s warranty.

Once connected to the mains supply, recharging of the battery can be left generally unsupervised, requiring minimal attention. Complex circuit construction monitors the battery condition, adjusting the recharge current to suit. When the recharge cycle is complete, to maintain the full capacity, a low output current will continue as required.

**Warning!** Check the condition of the charger and battery prior to each charge. If there is any sign of damage then do not commence charging, seek advice from Draper Tools.

The battery pack is supplied un-charged and must be charged before initial use.

Figs. 1 – 2 and the procedures set out below, illustrate an example of the D20 2.0Ah battery pack (Draper stock No.55887) used in conjunction with the D20 battery charger (Draper stock No.97914). For further information on your particular battery pack and charger combination, consult the instruction documentation supplied with the products.

To charge the battery pack (7), it must first be removed from the tool.

- Plug the battery charger (8) unit into a 230V/AC 13amp three pin supply socket.
- The red LED (8.1) will illuminate to show the charger has power.
- Slide the battery into the charger (the battery is shaped to fit into the charger one way only).
- After a few seconds delay, the red LED (8.1) will flash to show that charging has begun, then illuminate solid red.
- Whilst the battery is charging, the green LED (8.2) will flash, (the red LED will go from flashing to constant red).
- When the battery is fully charged the green LED stops flashing and remains a constant green. The red LED will extinguish.

**Caution:** Do not pull the plug out of the power supply by pulling on the cord. Make sure to grasp the plug when removing from power supply to avoid damaging the cord.

To remove the battery from the battery charger:

- Supporting the battery charger with hand, pull out the battery from the battery charger.



FIG.1



FIG.2

# 1. PREPARING THE GRASS & HEDGE TRIMMER

**Caution:** If the battery charger has been in continuous use it will be hot. Once the charging has been completed, leave the charger 15 minutes to cool until next use. If the battery is charged when it is warm due to battery use or exposure to sunlight, the battery will not be recharged. In such a case, let the battery cool before charging.

If the red indicator flickers rapidly at 0.2 second intervals, check or and remove any foreign objects in the charger's battery slot. If there are no foreign objects, it is probable that the battery or charger is malfunctioning. Allow battery/charger to normalise and try again. If a fault remains after trying this then contact Draper Tools.

## 8.2 BATTERY PACK PROTECTION FEATURES

**Overcharging protection:** This feature that ensures that the battery pack can never be overcharged. When the battery pack reaches full charge capacity, the transformer/charger will automatically shut off, protecting the internal components from being damaged.

**Over-discharging protection:** This feature will stop the battery pack from discharging beyond the recommended lowest safety voltage.

**Overheating protection:** The battery pack contains an internal thermistor cut-off sensor which shuts off the battery pack should it become too hot during operation. This can happen if the tool is overloaded or being used for extended periods. Up to 30 minutes cooling time may be required, depending on ambient temperature.

**Current protection:** Should the battery be overloaded and the maximum current draw be exceeded, the battery will shut off to protect the internal components. The battery pack will resume working once excessive current draw has returned to normal, safe level.

**Short circuit protection:** If, for any reason, the battery pack was to short circuit, the short circuit protection would immediately stop the battery pack from operating.

## 8.3 BATTERY PACK CHARGE STATUS – FIG. 3

To display the amount of charge left in the battery pack, press the charge level indicator button (7.2).

## 8.4 BATTERY LIFE EFFICIENCY AND CHARGING ADVICE

- Avoid recharging at high temperatures. A rechargeable battery will be hot immediately after use. If such a battery is recharged immediately after use, its internal chemical substance will deteriorate, and the battery life will be shortened. Leave the battery and recharge it after it has cooled for a while.
- The battery should only be used and/or charged when battery temperature is between 5°C and 30°C.
- The battery needs to be warmed-up or cooled down in order to prevent damage to the batteries internal components,

**Note:** If battery is too hot or too cold, allow it to 'normalise' before use or charging.

**Note:** Failure to warm up or cool down a battery could result in serious damage to the battery, charger and user.





Charge level indicator	Amount of charge remaining
	0 – 10%
	10 – 25%
	25 – 50%
	50 – 75%
	75 – 100%

FIG.3

# 1. PREPARING THE GRASS & HEDGE TRIMMER

## 8.5 FITTING THE HEDGE & GRASS CUTTING ATTACHMENTS – FIGS.4 – 6

**Warning!** Please wear the appropriate protective gloves before touching the blades:

- Squeeze in the locking buttons (9) on each side of the attachment (Fig.4).
- Locate the attachment with the bottom of the motor unit (Fig.5).
- Tilt the base plate until it engages fully with the hand unit. Release the locking buttons and the attachment will lock into place (Fig.6).

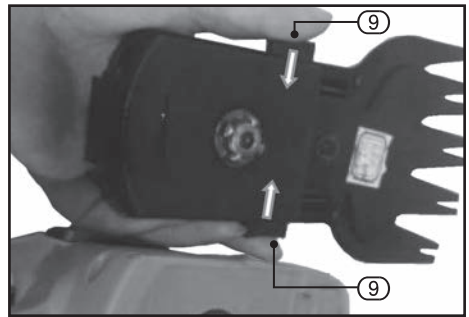

FIG.4

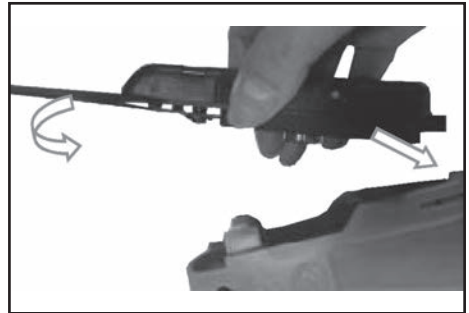

FIG.5

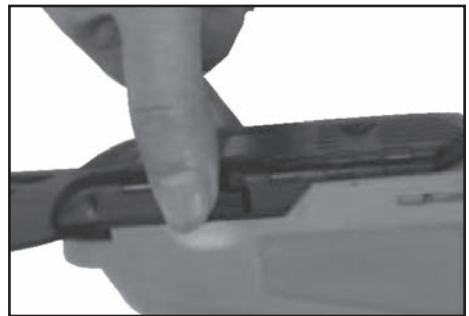

FIG.6

## 9. OPERATION

### 9.1 SWITCHING ON & OFF – FIG.7

This tool features a safety lock-off button (3) that prevents unintentional starting.

- Activate the safety lock-off button by pressing it in, whilst at the same time pressing the ON/OFF trigger (2).
- The tool will operate and the blade attachment move.
- To switch off, simply release the ON/OFF trigger.

**Warning!** The blades will continue to operate for a short period of time after the ON/OFF trigger is released.



FIG.7

# 10. MAINTENANCE AND TROUBLESHOOTING

## 10.1 GENERAL MAINTENANCE – FIG.10

Regular inspection and cleaning reduces the necessity for maintenance operations and will keep your tool in good working condition. Check the condition of the cutting edges of the blades, and always immediately remove notches and burrs caused by stones etc.

The cutting blade is set back from the edge of the safety rail which reduces the risk of injuries due to accidental contact with the blades. This gap is shown in the illustration below (B).

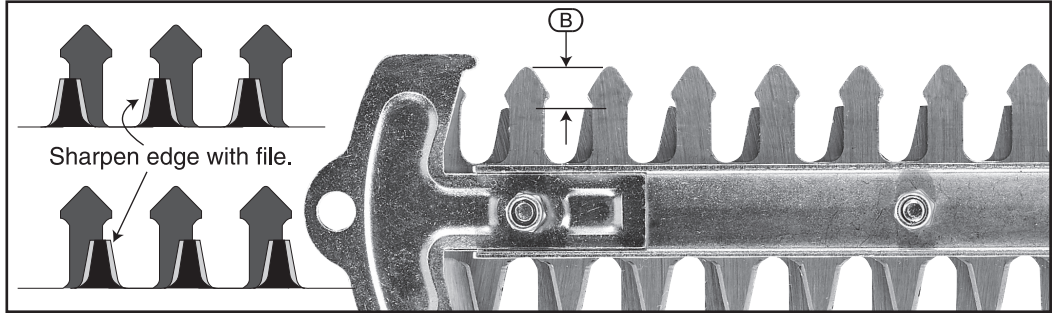

FIG.8

## 10.2 CLEANING & STORAGE

- Clean the exterior of the machine thoroughly using a soft brush and cloth. Do not use water, solvents or polishes.
- Remove all debris, especially from the ventilation slots.
- After use, remove all debris, use a light oil to lubricate and protect the blades, before fitting the guards provided.
- Charge the battery 3-5 hours before storing.
- During storage, charge the battery at least once every three months to protect it from damage.
- Store the machine in a dry, secure place out of reach of children.
- Do not place any other objects on top of the machine.
- The machine must not be stored over 35°C or under direct exposure to sunlight.
- Do not store the machine in locations where static electricity could be generated.

# 11. DISPOSAL

## 11.1 DISPOSAL

- At the end of the machine's working life, or when it can no longer be repaired, ensure that it is disposed of according to national regulations.
- Contact your local authority for details of collection schemes in your area.

In all circumstances:

- Do not dispose of power tools with domestic waste.
- Do not incinerate.
- Do not dispose of WEEE\* as unsorted municipal waste.



\* Waste Electrical & Electronic Equipment.

# 12. EXPLANATION OF SYMBOLS

---

## 12.1 EXPLANATION OF SYMBOLS



Read the instruction manual.



Wear face mask and safety glasses.



Wear protective gloves.



**Warning!**



**Warning!** Sharp objects



**Warning!** Moving blades.



**Warning!** Keep bystanders away.



**Warning!** Keep bystanders away.



**Warning!** Keep out of the reach of children.



**Warning!** Danger to wildlife.



WEEE –  
Waste Electrical & Electronic Equipment.  
Do not dispose of Waste Electrical & Electronic  
Equipment in with domestic rubbish.



Continuous A-Weighted Sound  
Pressure Level.

# CONTACTS

Draper Tools Limited, Hursley Road,  
Chandler's Ford, Eastleigh, Hampshire. SO53 1YF. U.K.

Delta International BV, Oude Graaf 8, 6002 NL, Weert, Netherlands

Help Line: (023) 8049 4344

Sales Desk: (023) 8049 4333

Internet: [drapertools.com](http://drapertools.com)

E-mail: [sales@drapertools.com](mailto:sales@drapertools.com)

General Enquiries: (023) 8026 6355

Service/Warranty Repair Agent:

For aftersales servicing or warranty repairs, please contact the  
Draper Tools Help Line for details of an agent in your local area

## YOUR DRAPER STOCKIST

TATL1023

©Published by Draper Tools Limited.

No part of this publication may be reproduced, stored in a retrieval system or transmitted in any form or by any means, electronic, mechanical photocopying, recording or otherwise without prior permission in writing from Draper Tools Ltd.